

Shandon Excelsior ES[®]
Operator Guide - English
A78410120 Issue 3



© 2006 Thermo Fisher Scientific. All rights reserved.

Thermo Shandon Limited is an ISO 9001 and TickIT Accredited Company

Thermo Fisher Scientific is the trading name of Thermo Shandon Limited

All other trademarks are the property of Thermo Fisher Scientific and its subsidiaries

Thermo Fisher Scientific makes every endeavour to ensure that the information contained in its support documentation is correct and clearly stated but does not accept responsibility for any errors or omissions. The development of Thermo products and services is continuous. Make sure that any published information that you use for reference is up to date and relates to the status of the product. If necessary, check with Thermo Fisher or your local Thermo representative. ▲

This manual may not, in whole or in part, be copied, photocopied, reproduced, translated, or converted to any electronic or machine readable form without prior written consent of Thermo Fisher.

All information contained in this manual is proprietary and confidential, and the exclusive property of Thermo Fisher Scientific. This manual is protected by copyright and any reproduction is prohibited. This manual is for use only by the individuals to whom it has been made available by Thermo Fisher Scientific.

Contact addresses

Anatomical Pathology
93-96 Chadwick Road
Astmoor, Runcorn,
Cheshire. WA7 1PR, UK

Anatomical Pathology
4481 Campus Drive
Kalamazoo
MI 49008, USA

Tel: +44 (0)1928 562600

Tel: 1-800-522-7270

Fax: +44 (0) 1928 562627

Fax: +1 269-372-2674

www.thermo.com/pathology

www.thermo.com/pathology



The Shandon Excelsior ES meets the following CE Mark requirements:
In Vitro Diagnostic Directive 98/79/EC
Low Voltage Directive 73/23/EEC, as amended by 93/68/EEC.



Contents

	How to Use This Guide	7
	Safety Information	8
1	Introducing Excelsior ES Overview; Excelsior ES Instrument Tour; Systems Monitoring; How You Process With Excelsior ES; About the Excelsior ES Interface; Menus and Options;	13
2	Daily Operations Mode Introduction; Option Keys; Loading Specimens; Level Key; Starting the Current Process; Starting a Different Process; Removing Specimens; The Quality Control Screen; Replacing Reagents, Reagent Rotation; Daily Options Menu.	23
3	Instrument Setup Menu Introduction; Set Clock; Define Reagent Groups; Load Reagent Groups; Colour Coded Reagent Tubes; Edit Program; Changing Program Title; Defining Programs, Program Step Parameters; Customisation; Process Start Selection Options; Rotation Management; Concept Demonstration; Daily Operations, Unload Reagent Groups; Daily Options Menu.	39
4	Menu Mode Introduction; Set Clock; Processing in Menu Mode; Loading Specimens; Starting the Current Process; Starting a Different Process; Removing Specimens; The Quality Control Screen; Replacing Reagents, Reagent Rotation; Options.	63

5	Installing Excelsior ES	85
	Introduction; Unpacking, Moving, Levelling; Connecting Monitor, Printer; Fitting Filters; Connecting to Mains Power; Powering ON and OFF; Standby.	
6	Troubleshooting	95
	Introduction; Alert Icons; The Fault Status Screen; Underfill Recovery; Problem / Cause / Remedy Tables and Frequently Asked Questions.	
7	Cleaning and Maintenance	105
Appendix A	Specification and Accessories	113
	Specification; Accessories, Part Numbers; Ordering Reagents; Declaration of Conformity.	
Appendix B	Approved Reagent List	119
	Introduction; Fixatives; Dehydrants; Clearants; Infiltrants; Flush Reagents; Cleaning Agents.	
Appendix C	Program Examples	121
	Routine Overnight Program; Rapid Biopsy Program; Standard Flush Program; Extended Flush Program; Rinse Program.	
Appendix D	Transportation Instructions	123
	Packaging the Instrument; Product Return Safety Declaration; Warranty Statement.	
	Index	128

Symbols

The following symbols and conventions are used throughout this manual and on the instrument.



THIS SYMBOL IS USED ON THE EQUIPMENT, OR IN A DOCUMENT, TO WARN THAT INSTRUCTIONS MUST BE FOLLOWED FOR SAFE AND CORRECT OPERATION. IF THIS SYMBOL APPEARS ON THE INSTRUMENT, ALWAYS REFER TO THIS OPERATOR GUIDE. ▲



THIS SYMBOL IS USED ON THE EQUIPMENT, OR IN A DOCUMENT, TO WARN THAT THERE MAY BE A BIOHAZARD ASSOCIATED WITH THE INSTRUMENT. ALWAYS ACT WITH COMMON SENSE AND BE AWARE OF THE SAMPLES USED. TAKE SUITABLE PRECAUTIONS. ▲



THIS SYMBOL WARNS YOU THAT SURFACES ARE HOT. IF THIS SYMBOL APPEARS ON THE INSTRUMENT, ALWAYS REFER TO THIS OPERATOR GUIDE. ▲



THIS SYMBOL IS USED ON THE EQUIPMENT, OR IN A DOCUMENT, TO WARN THAT HARMFUL CHEMICALS ARE USED WITH THE INSTRUMENT. REFER TO THE MATERIAL SAFETY DATA SHEETS FOR THE CHEMICALS USED. ALWAYS ACT WITH COMMON SENSE AND BE AWARE OF LOCAL LABORATORY PROCEDURES. TAKE SUITABLE PRECAUTIONS. ▲

WARNING

A warning is given in the document if there is a danger of personal injury or damage to samples or equipment. ▲

Note

Notes give more information about a job or instruction but do not form part of the instructions. ▲

How to Use This Guide

The Shandon Excelsior ES is intended for use in pathology laboratories by operators familiar with tissue processing techniques and laboratory equipment.

Before operating the instrument, you should read the section Safety Information on page 8.

This Operator Guide is structured to let you start processing quickly and safely with Excelsior ES.

Chapter 1 Introducing Excelsior ES gives you a tour of the instrument, explaining general principles of processing with Excelsior ES. You should now be ready to operate the instrument in Daily Operations mode. You can learn later about reagent management, programming and customising Excelsior ES.

Chapter 2 Daily Operations Mode shows you how to run defined process programs, replace and rotate reagents. These are with current settings.

Chapter 3 Instrument Setup Menu gives details of Excelsior ES programming, reagent loading and customisation.

Chapter 4 Menu Mode explains using Excelsior ES with all options available.

Chapter 5 Installing Excelsior ES shows you how to install the instrument on site, and correctly connect to an electrical supply.

Chapter 6 Troubleshooting explains alert symbols and gives instructions to clear them, using the Fault Status screen. The reference lists suggest solutions to common processing issues.

Safety Information

THIS SECTION DETAILS IMPORTANT SAFETY INFORMATION. PLEASE READ ALL OF THIS SECTION CAREFULLY.

Thermo products are designed for convenient and reliable operation and to accepted standards of safety. Their use does not entail any hazard if operated in accordance with the instructions given in this manual. However, incorrect actions by user may damage this equipment, or cause a hazard to health. It is important for you to obey the following safety precautions:

- All users must read and understand the Operator Guide and only operate the unit in accordance with the instructions. If the instructions are not followed, then the protection provided by the instrument may be impaired.
- Do not modify the instrument - if unauthorised modifications are carried out, the instrument may be made unsafe and the warranty may be invalidated.
- Potentially lethal voltages above 110V AC or 50V DC are present inside the instrument. The instrument must be properly connected to a good earth (Ground) via the mains input supply.
- Do not remove any panels or covers. There are no user serviceable parts inside the instrument.
- It is important to maintain normal standards of safety and Good Laboratory Practices. Always use common sense and the best known practice when operating the instrument.

- Excelsior ES, as supplied, conforms with the international safety standards, IEC 61010-2-010. However, adding chemical reagents introduces potential hazards. Good Laboratory Practice must be followed when dealing with these chemicals, and operators must consider the potential for hazard when dealing with particular chemicals.
- BEFORE using reagents, ALWAYS refer to your own laboratory procedures and manufacturer safety data sheets (MSDS).
- Many of the reagents used with Excelsior are flammable. Do not introduce any source of ignition into, or near, the instrument once it has been loaded with reagents. Sources of ignition include electrostatic discharge, resulting from a build-up of static electricity. This can, under certain conditions, result in ignition of fumes from any reagent used with Excelsior ES. Good Laboratory Practice must be followed and ALL necessary precautions taken.
- Where seismic regulations require the instrument to be secured, use the handle locations at the rear of the instrument (2 x M8 female threads). The Centre of Gravity position for a fully laden instrument is shown in the diagram:

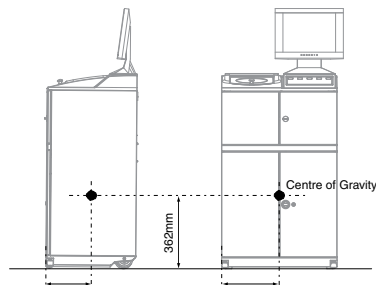

- Excelsior ES weighs approximately 112 kilograms (246 lbs) when empty. Do not try to move Excelsior on your own - at least two people are needed to move an instrument.

- If the instrument has been used with materials that are toxic or contaminated with pathogenic micro-organisms, follow the cleaning instructions given. Before returning the instrument to Thermo, the Product Return Certificate (see Appendix D) must be completed.
- All reagents and filters used with Excelsior ES may become contaminated. Personnel disposing of ALL reagents and filters used with Excelsior ES must follow local regulations for hazardous waste disposal.
- The instrument should be regularly cleaned as described in Chapter 7 of this Operator Guide.
- Use only factory approved accessories or replacement parts with Excelsior ES.
- Correct maintenance procedures are essential for consistent performance. It is recommended that a Maintenance Contract is taken out with your supplier.
- The instrument must be serviced annually by a Thermo-trained engineer in accordance with the instructions contained in the Shandon Excelsior ES Service Manual (A78410101).
- Any problems and queries should be referred to your supplier.

Disposal of Sealed Lead Acid Batteries

The Sealed Lead Acid batteries within Excelsior ES need to be replaced every two years.

Note

If Excelsior ES has been operated in very low temperatures for much of the time, or has been exposed to frequent mains failures, the batteries should be replaced every year. Batteries must only be replaced in pairs.

The battery manufacturers (Yuasa Battery Sale (UK) Ltd) advise their customers to comply with the relevant regulations within their particular country regarding disposal of this type of battery.

The batteries used in Excelsior ES are:

NP12-12, 12V, 12Ah, valve regulated sealed lead-acid type rechargeable battery.

These batteries are classified as, “Class 8, Group III UN No. 2800 Batteries, wet, non-spillable, electric storage, special provision A67”, and meet all requirements of the International Air transport Association (I.A.T.A. Dangerous Goods Regulations).

Chapter 1 - Introducing Excelsior ES

Overview The Shandon Excelsior ES is an enclosed automated tissue processor, combining custom programming with simple operation and reagent management.

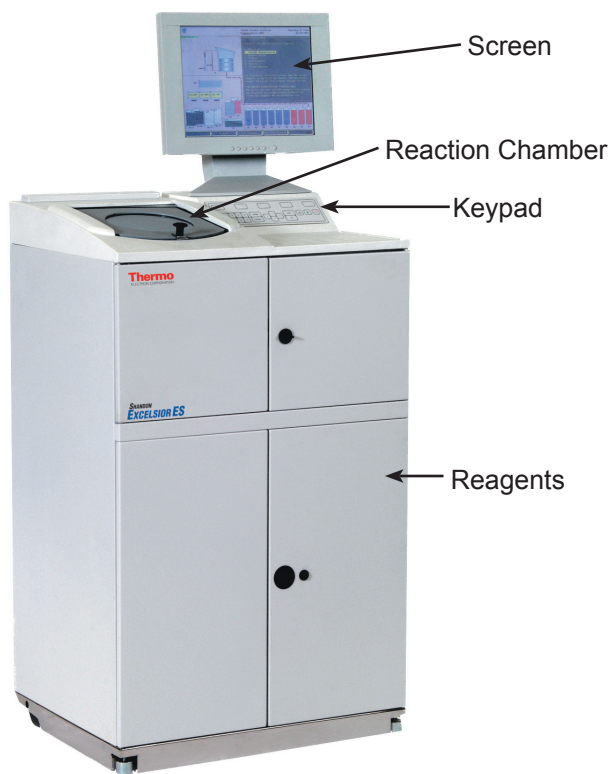

Excelsior ES Instrument Tour

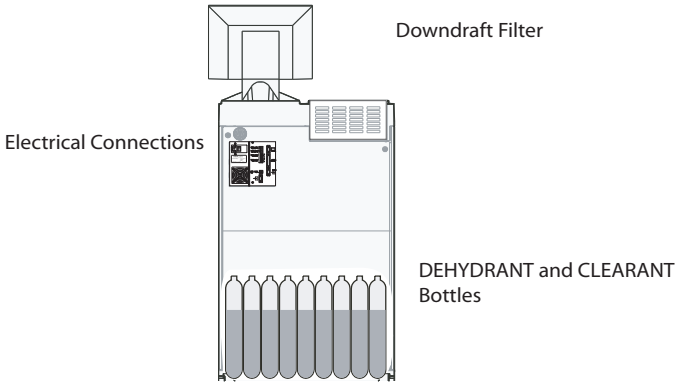
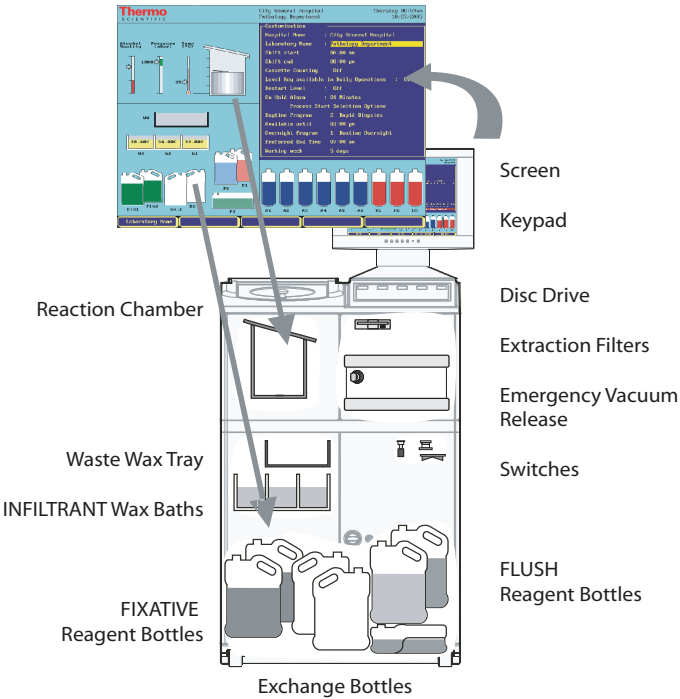

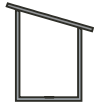

The Reaction Chamber is where processing of tissue specimens takes place, according to defined programs. When the lid is open, fumes are extracted through the Downdraft Filter.



The Screen has a menu window and a real time graphic display, and the Keypad is used to operate Excelsior ES. Five keys select menu options, with number and arrow keys for other controls.



The Disc Drive uses standard floppy discs for Excelsior ES data transfer options.

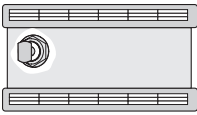

Two Extraction Filters clean the cabinet air - this helps to contain fumes within the instrument. Behind the baffle plate, the Vacuum Release Knob is for emergency situations only.

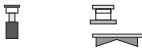

Switches inside the cabinet let you test and reset the heater, and isolate the battery.

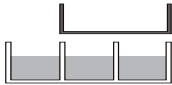

The Wax Baths store the infiltrant reagent, which is discarded into the Waste Wax Tray after reaching the usage limit.

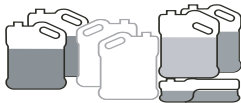

Fixative and Flush Reagent Bottles are in the front of the cabinet. Two Exchange Bottles are stored empty, ready for reagent exchange operations involving the concealed bottles.

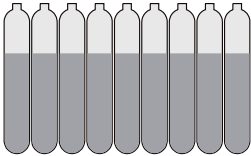

The concealed Dehydrant and Clearant Reagent Bottles fixed within are NOT accessible to operators.

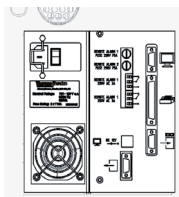

The Electrical Connections panel is for mains power and monitor, optional printer and remote alarms, data communications, and the instrument POWER ON / OFF switch.

Systems Monitoring

To assure processing quality and specimen security, Excelsior ES constantly monitors its systems and continuously updates the displayed status.

When you see the Thermo logo displayed at the top of the screen, this means all systems are OK. If Excelsior ES detects that part of the system is not OK, the Thermo logo is replaced by one or more alert icons.



The icons can indicate the need for reagent management and maintenance tasks, hardware issues and instrument faults. See Chapter 6 - Troubleshooting, for more information.

How You Process With Excelsior ES

You can put specimen cassettes into organised baskets arranged in pairs.

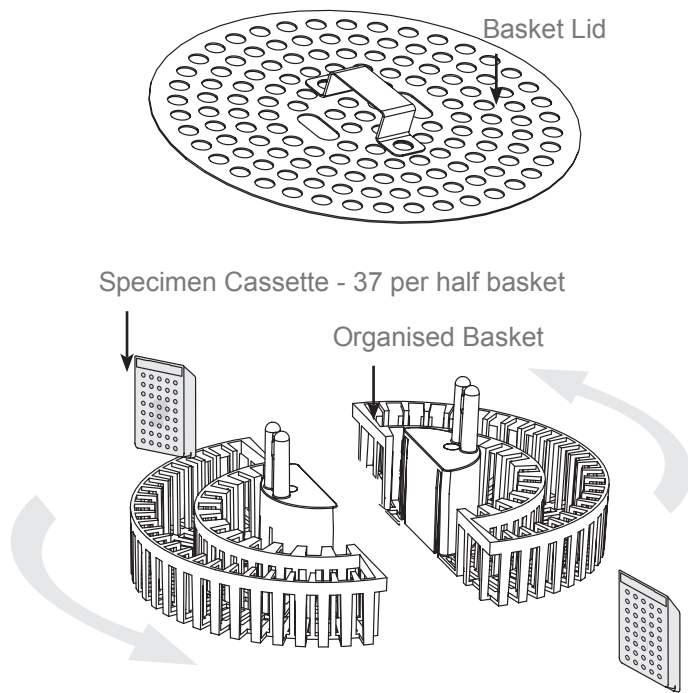

- You can process up to three Levels of organised baskets arranged in pairs. For larger specimens, use a random basket.



Up to 3 Levels of organised baskets

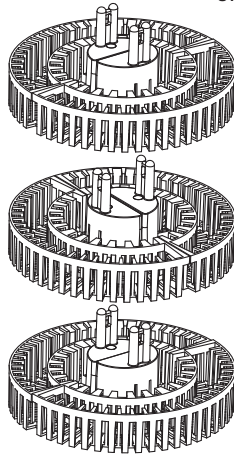

Random basket

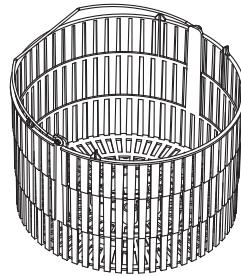

- You put the baskets into the reaction chamber, covering the specimens with a basket lid.

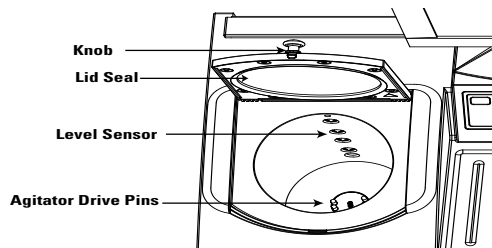

- You select a start option on the keypad.

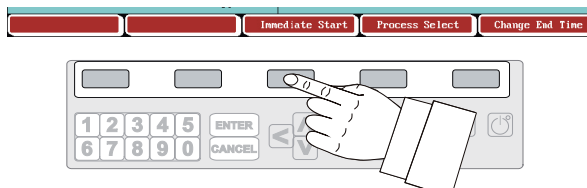

When you start a program, Excelsior ES moves through the process steps, drawing in reagents in turn and agitating the baskets to stir reagent around the specimens. The instrument can be set up to heat the chamber and put the chamber under constant or cycled vacuum conditions for process steps. This is described in Chapter 3 - Instrument Setup.

About the Excelsior ES Interface

Excelsior ES presents a uniquely compact, efficient and highly informative operator interface, showing:

- Reaction chamber status
- Program details and menu text
- Option keys
- Animated graphics showing processing and reagent movement in real time
- On-screen help information

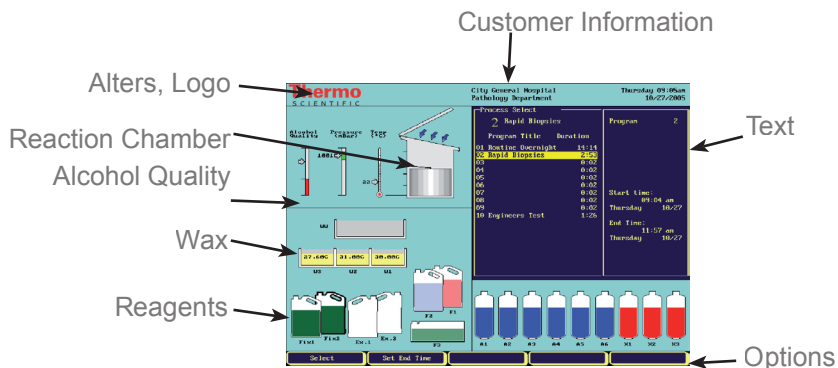

- You press one of the five keys to select an option. The options are grouped according to the instrument mode and displayed menu. The interface lets you perform tasks intuitively, efficiently, and consistently.
- Press **EXIT** to close a menu and return to a previous menu

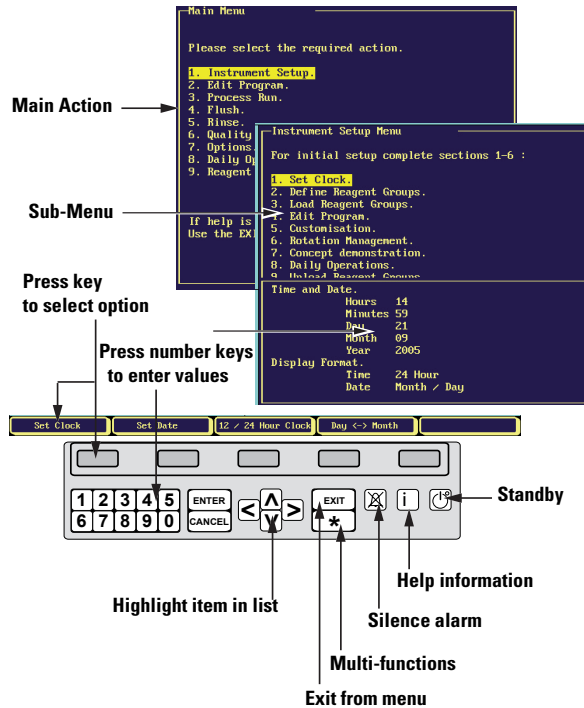

Menus, Keys and Options

- Using a menu is summarised below; Press a number key, OR highlight one of the sub-menus with the arrow keys
- Select one of the five options displayed
- Press **i** to show instructions or more information.

Processing in Menu Mode

You can use Main Menu Actions 3 - 6, for routine processing and reagent replacement.

This way of using Excelsior ES enables quick modification of program and reagent parameters where needed.

Processing in Daily Operations Mode

For the convenience of laboratories not needing flexibility at all times, a Daily Operations mode is available, where setup, program and reagent parameters cannot be changed. Return to Menu Mode can be protected by access code. This is explained in Chapter 4 - Menu Mode.

About Thermo Approved Reagents

Excelsior ES should be installed and used, loaded ONLY with reagents from the Thermo approved reagent list on page 119. You should not use any other reagents with Excelsior ES under any circumstances.

About Reagents - Fixatives

Excelsior ES uses fixative in positions Fix 1 and Fix 2 in the front of the cabinet. Two bottles (5.0L) are supplied with the instrument, for fixative storage.

About Reagents - Dehydrants

Dehydrants are stored in six concealed bottles, at positions A1 - A6 in the back of the cabinet. The bottles are loaded with solutions of different concentrations.

- The bottles are permanently fixed and not accessible to operators. You work with one exchange bottle at position

Chapter 2 - Daily Operations Mode

Introduction

From Main Menu, select 8. Daily Operations to display the Daily Operations screen, below.

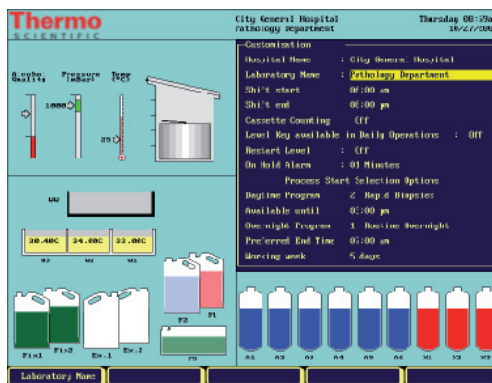

Routine processing, flushing and reagent management are available - no other menus are needed.

Daily Operations Overview

- When you open the reaction chamber lid, the red status screen shows the current processing program.
- After processing is complete, Excelsior ES automatically shows the flush program to clean the chamber.
- When reagents or filters are depleted, Excelsior ES informs you which items need to be replaced.

Selection Keys Described

[PROCESS] displays a red status screen with a current process program.

[FLUSH] displays a red status screen with a current flush program. Use this to run separate flush and rinse cycles outside of routine processing, as may be required.

[OPTIONS] displays the Daily options screen, described at the end of this chapter.

[QUALITY CONTROL] displays the Quality Control screen. Use this for reagent management.

Loading Specimens

1. Open the reaction chamber - push the knob and lift the lid to display the red status screen.

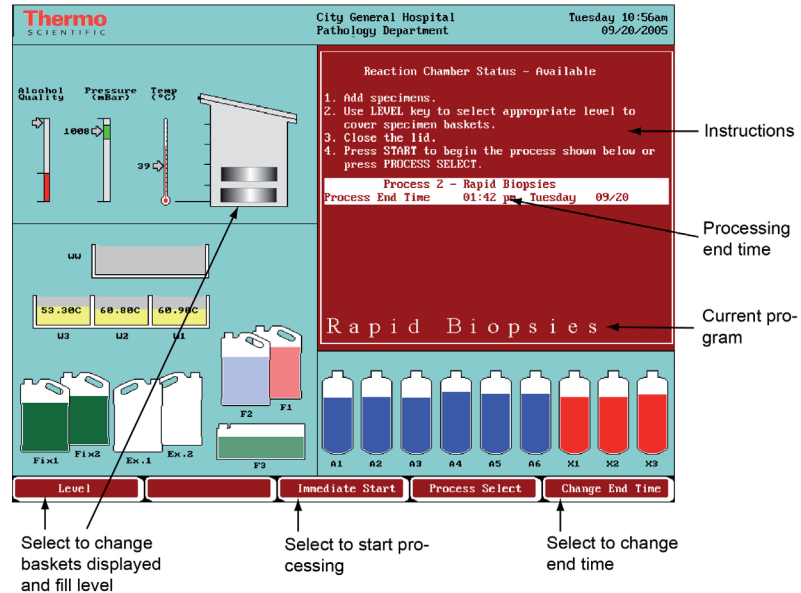

2. Load baskets (with a basket-lid) into the chamber, stacked in uniform pairs, and aligned so they sit properly on the agitation drive pins.
3. Close the reaction chamber lid, pushing down on both sides of the knob to ensure a good seal.

If there is no [LEVEL] key shown, go to 'Starting Current Process'.

Level Key



Select [LEVEL] once for each pair of organised baskets, up to three times for three pairs of baskets. Select [LEVEL] four times for a random basket. Ensure that the screen shows the baskets you put in the chamber. If too many baskets are shown, press the [LEVEL] key until the display is correct.

If you do not select [LEVEL], Excelsior ES assumes a random basket and fills the chamber to the highest level.

Starting the Current Process

Select [IMMEDIATE START] or [DELAYED START], according to the current program, for daytime or overnight processing.

Monitoring the Process Start

The monitoring screen is displayed, shown below.

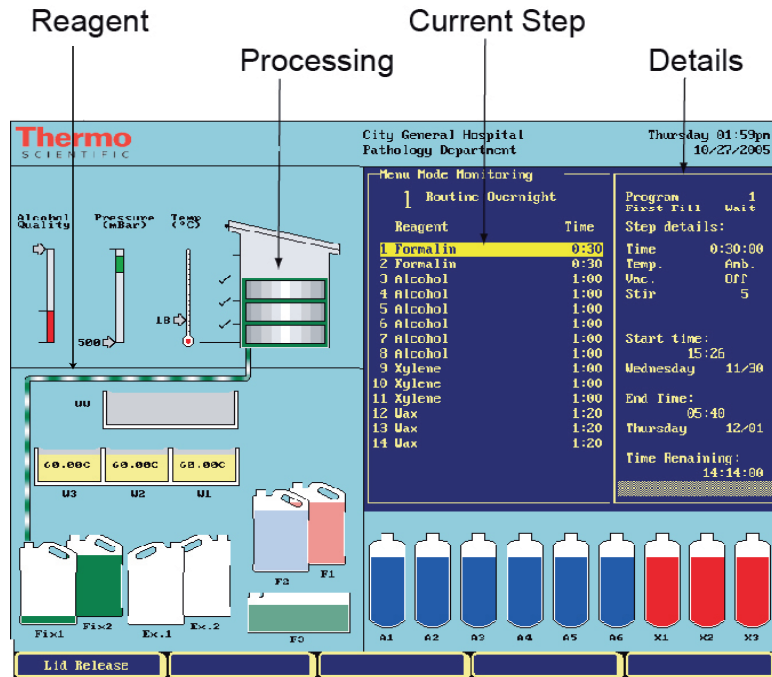

The status is shown as 'First Fill - Wait'.

Ensure that:

- The first reagent is drawn into the reaction chamber, and the status line changes
- The monitoring screen shows that the chamber is filled to the correct level.
- The baskets are completely covered with reagent.

Starting a Different Process

1. Select [PROCESS SELECT] to display the Process Select screen.
2. Highlight the program you want, and check that the End Time is correct.
3. Select [IMMEDIATE START] or [DELAYED START].

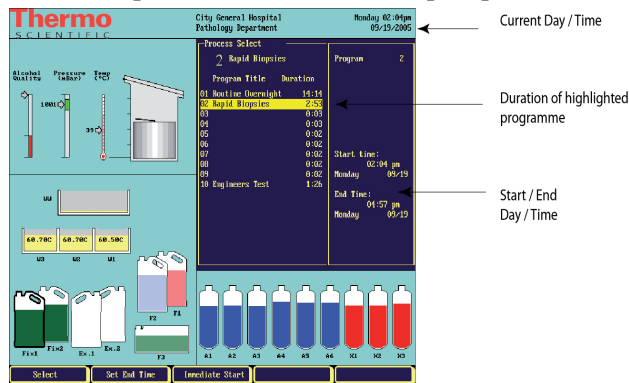

Changing the End Time

1. Select [CHANGE END TIME].
2. Select [SET END TIME].
3. Enter the time with the number keys and use the AM / PM key if necessary. Ensure that End Time and Process are correct.
4. Select [DELAYED START].

Changing the End day

1. Select [CHANGE END TIME] to highlight the time.
2. Select [SET END TIME].
3. Select [NEXT DAY] on the menu and press the key until Day and Date are correct. If you press too many times and go past the day you need, you can select [PREVIOUS DAY]. You can set Day and Date up to seven days in advance.
4. When End Time and Day are correct, select [DELAYED START].

Adding Specimens After Starting Process

You can add tissue cassettes after a process has started;

1. Select [LID RELEASE]. Wait for the downdraft fan to start and for the vacuum to release, if the step uses vacuum.
2. Open the lid, add cassettes or baskets, then close the lid. Follow either 3 or 4 below.
3. In the event that you do not add more baskets or are using a random basket, simply select [RESTART]. This continues processing to the original fill level.
4. If you do add additional baskets and the [LEVEL] key is enabled, press the [LEVEL] key accordingly. The basket level shown on the screen must correspond with the baskets in the chamber.
Then select [REFILL AND RESTART]

No Baskets Added

Baskets Added

Note

With the [LEVEL] key enabled and Restart set to ON, the chamber is refilled to the random basket level.

For more information on Level and Restart options, see Chapter 3 Instrument Setup - Customisation - page 51).

Aborting a Process

From the monitoring screen,

1. Select [STOP].
2. Select [ABORT].

The process is stopped and the reaction chamber drains.

When Processing is Complete

The status line on the monitoring screen displays 'Process Complete'. You have to:

- Drain the reaction chamber
- Remove baskets
- Wipe away excess wax from the chamber, lid and seal
- Flush and rinse the chamber

Removing Specimens

1. Select [DRAIN ALL CHAMBER] and wait till draining stops.
2. Open the lid and remove basket(s). If baskets are still shown in the chamber, press the [LEVEL] key to clear them.
3. Wipe out the reaction chamber.

With the [LEVEL] key enabled, you can remove baskets a level at a time after infiltration:

1. Select [DRAIN NEXT LEVEL] and wait till draining stops.
2. Open the lid and remove basket (s).
3. Press [LEVEL] so the screen shows the number of baskets in the chamber. Repeat steps 1 - 3 until the chamber is empty.
4. Wipe out the reaction chamber.

Flushing and Rinsing the Reaction Chamber

When the screen shows there are no more baskets in the chamber, the Flush screen appears automatically - you are required to flush the wax in the reaction chamber before starting the next process.

1. Put empty basket(s) back in the reaction chamber, and close the lid.
2. From the displayed Flush screen, select [START].
For a different Flush program, select [SELECT FLUSH].
3. When the monitoring screen shows the Flush program has finished, remove basket (s).
4. Select [OK].

Excelsior ES is ready to start a new process run.

About the Quality Control Screen

Press [QUALITY CONTROL] to display the Quality Control screen, below. It shows;

- Count - number of times reagents and filters have been used
- Limit - the number of uses before alerts are displayed
- Arrows - indicating items which have reached limits
- Rotation information - Rotation/Discard due or Will Not Rotate/Discard

Position	Reagents	Count	Usage Limit
Quality Control / Rotation Checklist			
		Count	Limit
Fix1	Formalin	8	7 <
Fix2	Formalin	5	7
Control All Groups			
A1	Alcohol	10	
	Will not rotate next run	0%	used
X1	Xylene	8	
	Will not rotate next run		
W1	Wax	8	
	Will not discard next run		
F1	Flush 1	4	5
F2	Flush 2	4	5
F3	Flush 3	4	5
	Downdraft filter	14	13 <
	Fixative filter	2	13
	Charcoal filter		

If the Quality Control screen appears automatically when you start processing, this means a usage limit has been reached.

Setting Usage Limits

For Fix1, Fix2, Fix3, F1, F2, F3, the limit is based on counts only. The limits are set in the Quality Control screen, but this can be done in Menu Mode only.

For filters, the counts are displayed in weeks.

For A1, X1 and W1 the limit can be based on:

- Specific Gravity
- Usage counts
- Day of the week

The limit can only be changed from the Instrument Setup / Rotation Management menu. This is only available in Menu Mode - see page 56.

Control All Groups

This refers to the rotation of dehydrants, clearants and infiltrants. If these reagents reach their usage limits at the same time, the Control All Groups line is highlighted, showing that this feature is available, and you can rotate the three reagent groups together.

Quality Control and Yellow Triangle Alerts

For fixative and flush reagents, when the usage limit is reached, a yellow triangle is displayed in the reagent bottle and at the top of the screen.

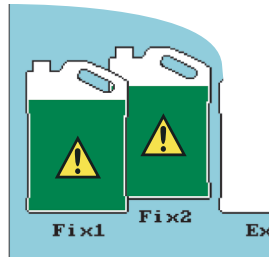

When the usage limit is reached for filters an alert triangle is displayed at the top of the screen only.

- For dehydrants, clearants, and infiltrants (wax), the Quality Control screen is displayed automatically at the beginning of a process run. If alcohol quality at bottle A1 is set as the trigger for rotation, a triangle is displayed above the alcohol quality gauge.

Replacing Fixative Reagents - Fix1-2

When you see the yellow warning triangle alert inside fixative and flush reagent bottles, you should change the reagents before running the next process. Open the lower doors - the Quality Control screen appears. Then:

1. Remove the reagents and 'tell' Excelsior ES.
 - a: Take out the Fix1 and Fix2 bottles and discard them.
 - b: Highlight Fix1 and select [REMOVE].
 - c: Highlight Fix2 and select [REMOVE].

2. Place the new reagents and ‘tell’ Excelsior ES.
 - a: Put new bottles of fixative in positions Fix1 and Fix2.
 - b: Highlight Fix2 and select [NEW].
 - c: Highlight Fix1 and select [NEW].

This zeroes the Quality Control counter, and removes the warning triangles from the screen.

Replacing Flush Reagents - F1-3

Open the lower doors and remove flush reagents in the order F2, F1, F3. In the Quality Control screen:

1. Highlight F2 and select [REMOVE].
2. Repeat for F1 and F3.
3. Place the new reagents in positions F3, F1, F2. In the Quality Control screen, highlight each reagent in turn, and select [NEW].

Reagent Rotation - Overview

Excelsior ES rotation is a unique in-process system for maintaining dehydrants, clearants and infiltrants.

- Excelsior ES discards the used reagent from the appropriate containers (used for the first steps in these processing groups).
- Excelsior ES rotates the rest of the reagents.
- Excelsior ES uses the fresh reagents in the last step for those process groups which have been rotated.

Reagent Rotation - Example 1

An example procedure is described here - the feature 'Control All Groups' in the Quality Control screen enables alcohol in A1, xylene in X1, and wax in W 1 to be replaced together. The timeline assumes a schedule of one process run per day.

DAY 1

The alcohol quality has reached its defined limit and a triangle is displayed above the alcohol quality indicator. The Quality Control screen is displayed automatically when the next processing run is due to begin.

1. In the Quality Control screen highlight the text 'Control All Groups'. *The text below alcohol and xylene is - 'Rotation Due next Run'. The text below wax is - 'Discard Due next Run' The selection key options are [ACKNOWLEDGE ALL] and [POSTPONE ALL].*
2. Select [ACKNOWLEDGE ALL].
3. Open the doors to ensure that containers Ex1, Ex2 and WW are empty (waste wax tray WW should have a liner).
4. Run your next process to continue with the rotation.

Excelsior ES uses reagents as usual from A1, X1 and W1, discarding them into the exchange positions (and the waste wax tray).

After the process steps using reagents A2, X2 and W2, these are not returned to these positions - they are moved forward by one position and become the new reagents for A1, X1 and W1. This continues for all subsequent reagents.

DAY 2

The next morning, the screen indicates A6, X3, and W3 are empty, whilst Ex1, Ex2 and WW are full as shown.

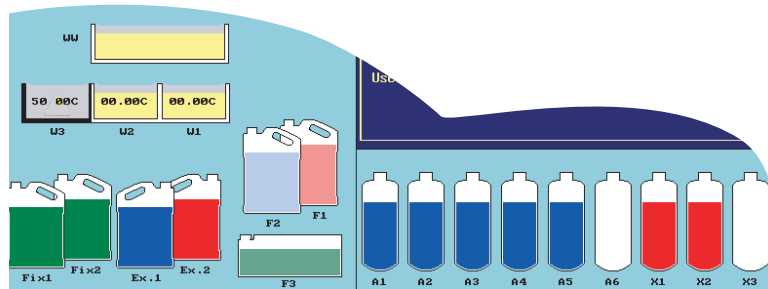

1. Replace the wax.

- Open the cabinet doors, and take out the waste wax tray WW. The Quality Control screen appears.
- Take the second waste wax tray WW supplied with the instrument, and put it, with a new liner, back in the cabinet. In the Quality Control screen, highlight WW and select [CONFIRM EMPTY].
- Add paraffin wax pellets to the empty wax bath W3. Highlight wax, and select [START HEATING]. While the wax is heating, go to 2 below.

2. Replace alcohol and xylene.

- Take out containers Ex1 (waste alcohol) and Ex2 (waste xylene) and dispose of them.
- Place fresh 100 % alcohol and fresh xylene into positions Ex1 and Ex2.
- In the Quality Control screen highlight the text under alcohol and select [NEW]. Highlight the text under xylene and select [NEW].

3. Transfer reagents to concealed bottles.

- Before continuing, ensure that the wax level is correct.
- Running your next process completes the reagent rotation.

Reagent Rotation - Example 2 Control All Groups

Examples of reagent rotation procedures are described here, for rotating reagents as directed by the Quality Control screen. The timeline assumes a schedule of one process run per day.

DAY 1

The alcohol quality has reached its defined limit and a triangle is displayed above the alcohol quality indicator. The Quality Control screen is displayed automatically when the next processing run is due to begin. It shows that alcohol and wax have reached the usage limit, but xylene has not.

In the Quality Control screen.

The text below alcohol is 'Rotation Due next Run'.

The text below xylene is - 'Will not Rotate next Run'.

The text below wax is - 'Discard Due next Run'.

1. Highlight alcohol and select [ACKNOWLEDGE]
2. Highlight wax and select [ACKNOWLEDGE]
3. Open the doors to ensure that containers Ex1 and WW are empty (waste wax tray WW should have a liner).
4. Run your next process.

Excelsior ES uses reagents as usual from A1 and W1, discarding them into the exchange positions (and the waste wax tray).

After the process steps using reagents A2 and W2, these are not returned to these positions - they are moved forward by one position and become the new reagents for A1 and W1. This continues for all subsequent reagents.

DAY 2

The next morning, the screen indicates A6 and W3 are empty, whilst Ex1 and WW are full as shown.

1. Replace the wax.

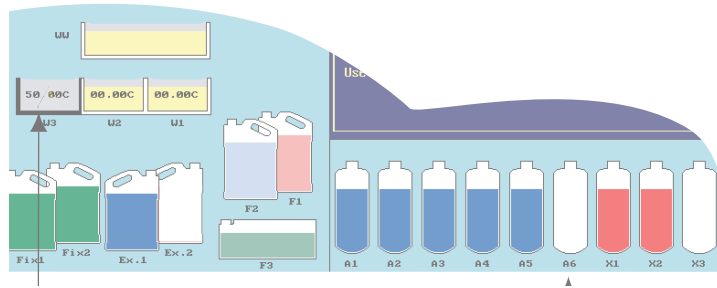

- Open the cabinet doors, and take out the waste wax tray WW.
- The Quality Control screen appears.
- Take the second waste wax tray WW supplied with the instrument and put it, with a new liner, back in the cabinet.
- In the Quality Control screen, highlight WW and select [CONFIRM EMPTY].
- Add paraffin wax pellets to the empty wax bath W3.
- Highlight wax, and select [Start Heating].
- While the wax is heating, go to 2 below.

2. Replace alcohol.

- Take out container Ex1 (waste alcohol) and dispose of.
- Place fresh 100 % alcohol into position Ex 1.
- In the Quality Control screen highlight the text under alcohol and select [NEW].

3. Before continuing, ensure that the wax level is correct.

- Running your next process completes the reagent rotation.

Daily Options Menu

From the Daily Operations screen, select [OPTIONS] to display the Daily Options screen, below.

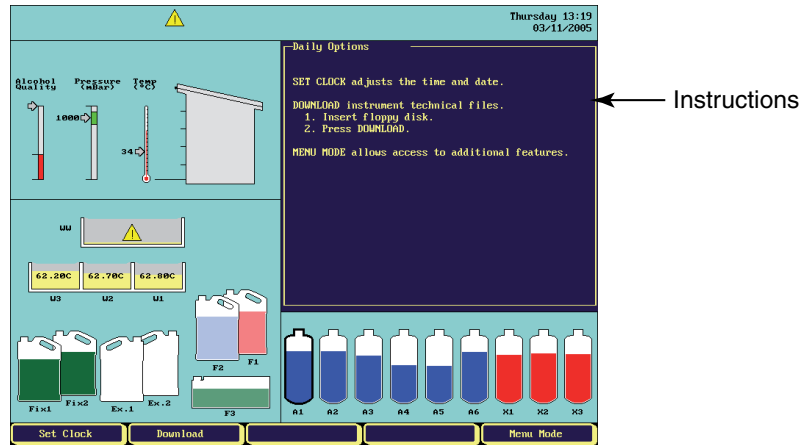

Download

Select [SET CLOCK] to display the setting options, if necessary. Select [MENU MODE] to move to Main Menu.

You can download instrument technical files to a 3.5 inch floppy disc. Before inserting it into the floppy disc drive, ensure that the disc complies with the following;

- Formatted for IBM - PC
- Ensured to be virus-free with an up-to-date virus checker
- Contains no data
- Not write-protected

ALL of the above must be satisfied for the download to be successful. If you are unclear about any of these details, consult your IT Manager.

1. Open the upper-right door, and insert the disc.
2. Select [DOWNLOAD].
3. When the lamp is no longer illuminated, the download is complete and you can remove the floppy disc.

Summary

You have

- Processed your tissue specimens.
- Flushed the instrument.
- Replaced fixative and flush reagents.
- Managed the replacement of the dehydrants, clearants and wax across twelve containers, using one rotation procedure.

Regular Maintenance

The following table describes items for regular checks.

AREA	ITEM	CHECK
WAX BATHS	LEVEL	Check wax levels in all wax baths. Carry out this check every day.
LID	SEAL	Always keep the lid and seal clear of solid wax deposits.
	LATCH	Check that the lid latch operates correctly whenever lid is opened. The downdraft system should operate and the reaction on-screen should show the lid open.
REAGENT STORAGE AREA	REAGENT TUBES	When loading or unloading reagents, check that the flexible parts of the reagent tubes in the front of the cabinet are not damaged or collapsed.
	REACTION CHAMBER HEATER TRIP	Press the red Heater Trip next to the Reset button in the Reagent Storage Area. The Heater Reset switch should operate and the reaction chamber Heater trip icon will be displayed on the screen . Press the Heater Reset switch fully in to reactivate the reaction chamber heaters. The reaction chamber Heater Fault icon will disappear from the screen. Carry out this check every month.
	BATTERY ISOLATION SWITCH	Check the operation of the switch. When the O side is pressed (OFF), the battery fault icon should be displayed. When the I side of the switch is pressed (ON), the icon should disappear. Carry out this check every month.

Chapter 3 Instrument Setup Menu

Introduction

You access the Instrument Setup menu from Main Menu when you need complete control of the Excelsior ES configuration. Examples are:

- Commissioning a new instrument and loading reagents. Complete sections 1 - 6 as shown on the screen, below.
- Adapting an installed instrument to specific processing needs.

With Instrument Setup you can change the parameters set above at any time.

- Removing loaded reagents to prepare an instrument for transportation.

This is explained in section 9. Unload Reagent Groups.

This chapter describes practical use of the menu sections and the selection keys to achieve associated instrument tasks.

From Main Menu, select 1. Instrument Setup.

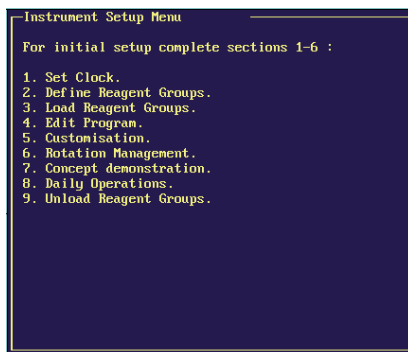

1. Set Clock

1. Select 1. Set Clock to display clock settings in the screen.

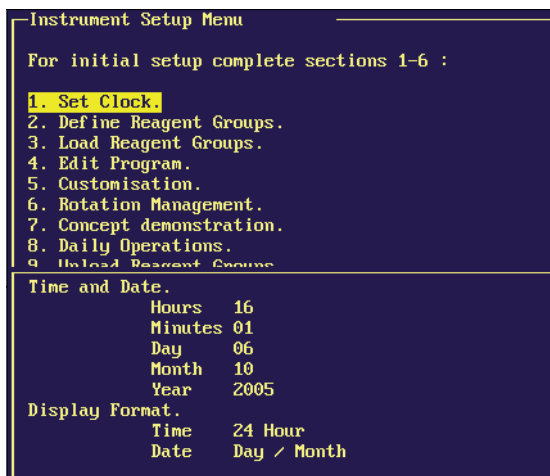

Select a key to highlight settings

2. Select [SET CLOCK] or [SET DATE] to highlight the settings and display the [SET] options key.
3. Use the number keys to change the parameters.
4. When the clock is correct, Select [SET].
5. Select [12/24 HOUR CLOCK] and [DAY<>MONTH] keys to change the display format.

2. Define Reagent Groups

Select 2. Define Reagent Groups to display a sub-menu with:

- Storage temperatures for the concealed reagents
- Reagent group names

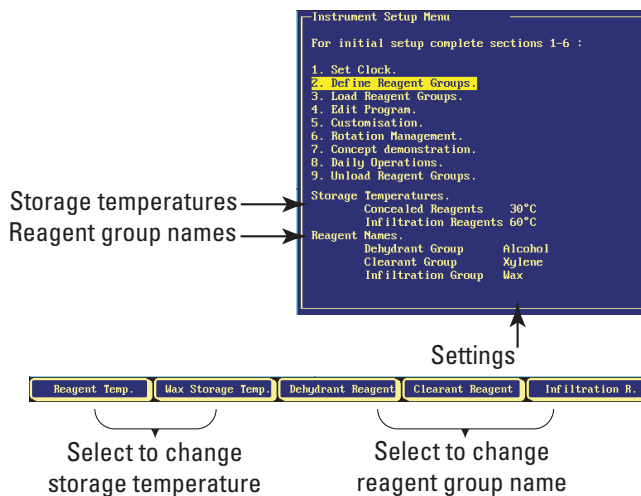

Excelsior ES can heat the concealed reagents during storage, for faster, more consistent processing. The defaults are 30°C for the concealed reagents and 60 °C for wax. Storage at ambient temperature is available, described below.

To change the storage temperatures:

- Select [REAGENT TEMP.] or [WAX STORAGE TEMP.].
- For concealed reagents, select [AMBIENT] or use the number keys (up to a maximum of 35 °C), then press [EXIT].
- Wax is stored in the molten state, so the ambient temperature option is not applicable.
- The available range is 45 °C to 65 °C.
- Thermo recommends wax storage temperature 4 °C above melting point. ▲

Note Do not set the temperature of the concealed reagents to more than 15°C above the minimum ambient laboratory temperature. ▲

Changing Reagent Group Name

To change a reagent group name,

1. Select a group - [DEHYDRANT REAGENT], [CLEARANT REAGENT] or [INFILTRATION R].
A pre-defined reagent list is displayed.
2. Choose a group name from the displayed list, and select [SELECT], OR move down the list to a blank position.

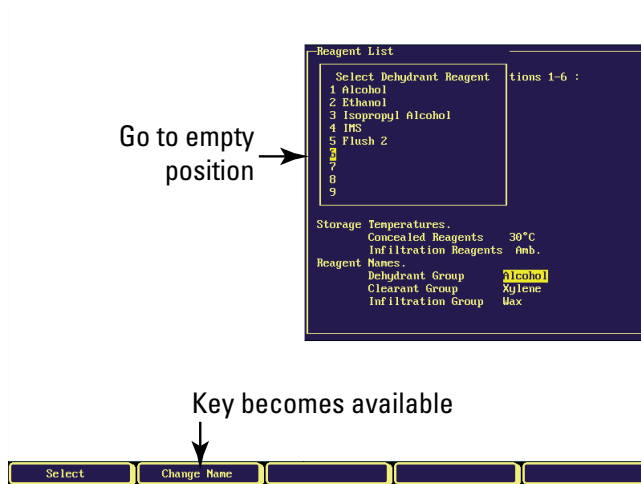

3. A new key is displayed, [CHANGE NAME]. Select this to display a QWERTY keyboard on the screen, as shown.

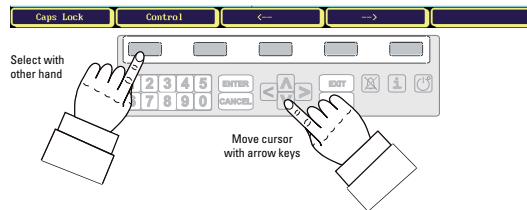
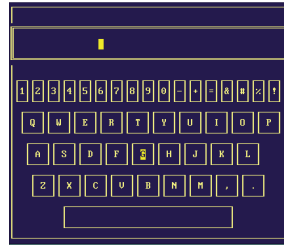

4. Highlight the first letter (move around the displayed QWERTY keys with the keypad, as shown). The procedure is easy using both hands.
 Select [CAPS LOCK] to display capital letters.
 Select [CONTROL] to display accents, umlauts, and other characters.
5. Press **ENTER** to put the highlighted character into the Reagent Name.
 Select [CAPS LOCK] to return to plain letters.
6. Repeat for all characters required.
7. Press **EXIT** to set the Reagent Name and return to the previous menu.

Move down to the next item in the list.

3. Load Reagent Groups

Use this menu to load an instrument with reagents. Excelsior ES uses reagent bottles between 3.8 L and 5.0 L.

The Load Reagents screen, below, shows all bottles and wax containers empty. You have to;

- Put the reagents in the correct cabinet positions, and insert the colour-coded reagent tubes (with evaporation cap).
- Confirm in the screen that they have been loaded.

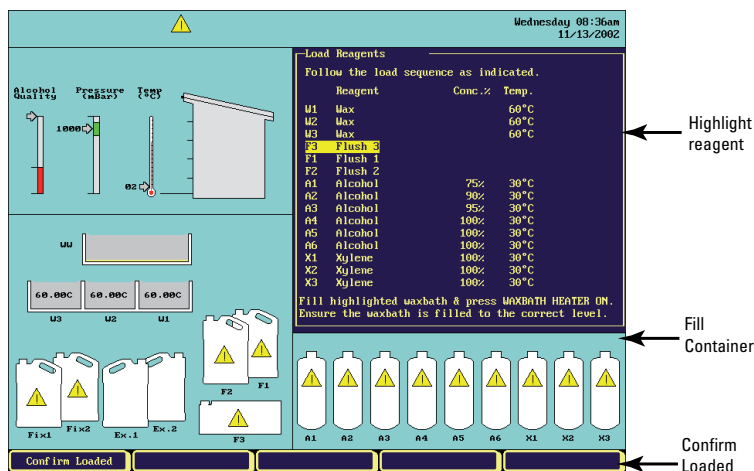

- Move down the reagent list and load reagents in the order - wax, flush reagents, dehydrants, clearants. Fixatives are loaded from the Quality Control screen.

Loading Wax

Refer to the diagram below for wax loading.

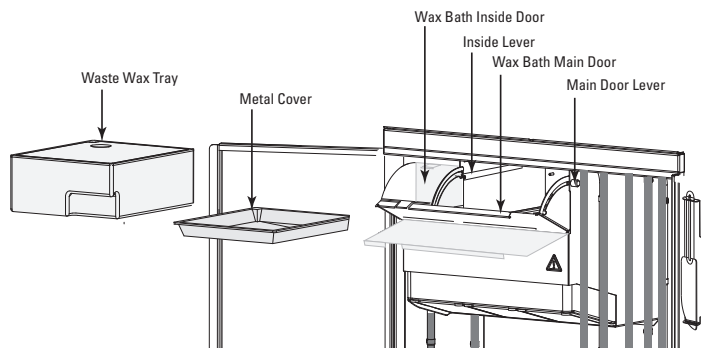

Wax loading involves:

- Removing the waste wax tray and metal cover
- Filling the three wax baths with wax pellets
- Replacing the metal cover and waste wax tray (this should include liner and lid)
- Starting the wax heater.

The wax bath main door has two open positions, set with the two levers.

- Use the main lever to put the door in the open (horizontal) door position. This lets you move the waste wax tray.
- Use the inclined door position when adding wax pellets.

1. Open the wax bath main door to the open position.
2. Pull out and remove the waste wax tray and metal cover.
3. Pull down the inside door to the open position - this lets you return both doors together, to the inclined position.
4. Attach the wax fill chute, as shown.

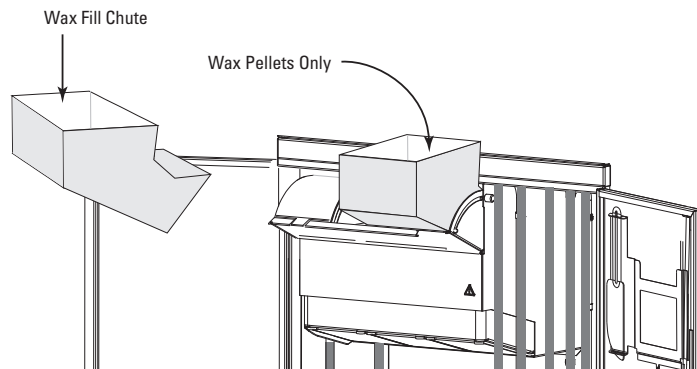

Starting from the right, carefully fill each wax bath with wax pellets.

Ensure that the wax pellets are evenly distributed in the wax bath - push them towards the back if necessary. You can fill to within a few millimetres from the top of the dividing wall - the pellets melt to the final, lower level within approximately 4 hours.

Take care not to spill any wax pellets.



**RISK OF SKIN BURNS FROM MOLTEN WAX.
DO NOT FILL THE EXCELSIOR ES WAX BATHS
WITH MOLTEN WAX - USE WAX PELLETS ONLY.▲**

Wax bath W1 is highlighted on the screen.

5. Select [WAXBATH HEATER ON] to switch on the wax bath heaters and melt the wax pellets.
6. Follow the screen instructions, and repeat the key selections for wax baths W2 and W3.
7. When the wax has melted, ensure that the level reaches the top of the interior walls of the wax baths.
8. If the level is too low, add more wax pellets.
9. Fit a new liner into the waste wax tray, then replace the metal wax cover, waste wax tray and lid.
10. Close the wax bath main door.

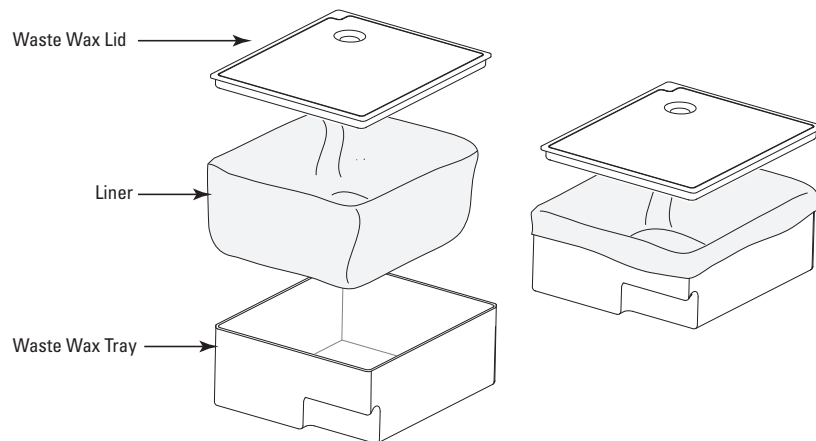

Excelsior ES is now ready for loading the rest of the reagents.



REFER TO THE MATERIAL SAFETY DATA SHEETS (MSDS) WHEN HANDLING ALL REAGENTS USED WITH THE INSTRUMENT. ▲

ENSURE THAT THE COLOUR-CODED REAGENT TUBES ARE FULLY INSERTED INTO THE BOTTLES. ▲

About Colour Coded Reagent Tubes

The diagram below shows the colour of the tube for each reagent position.

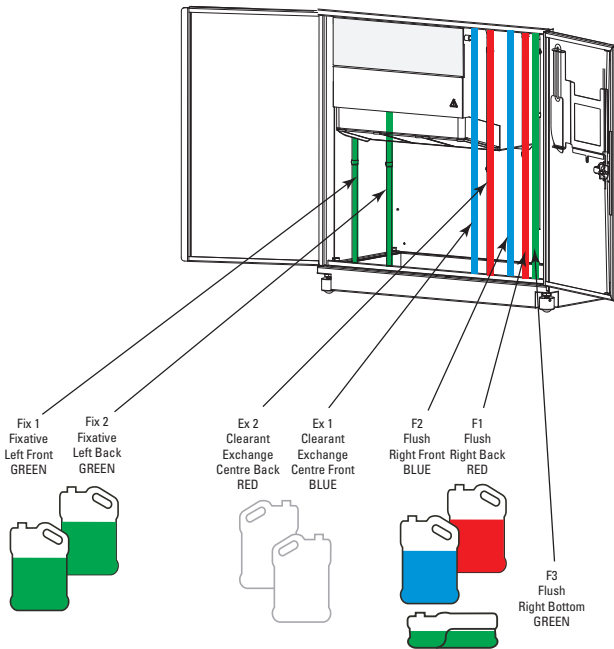

Ensure that each pipe is:

- Fully inserted in the bottle
- Not bent, twisted or kinked



Loading Flush Reagents

Flush reagents must be loaded in the order F 3, F 1, F 2.
F 3 - Flush 3 should be highlighted first on the screen. When removing bottle caps keep them safely - they are needed when the reagent is changed.



FLUSH 3 IS A WATER RINSE USED DURING THE LOAD ROUTINE AND FOR THE THIRD FLUSH REAGENT. ▲

DO NOT USE XYLENE AS THE THIRD FLUSH REAGENT. ▲

LOADING FLUSH 3

1. Fill the Flush 3 bottle (supplied with Excelsior ES) to the bottom of the neck with water.
2. Replace the cap securely, and put the GREEN reagent tube into the bottle.
3. Select [CONFIRM LOADED].

The screen moves to F1 Flush 1, highlighting the text and outlining the bottle.
In positions F1 and F2, Excelsior ES uses manufacturers' reagent bottles.

LOADING FLUSH 1

1. Take a new bottle (3.8 - 5 litres) of the first flush reagent, e.g. xylene.
2. Place the bottle on top of the Flush 3 bottle, and insert the RED reagent tube (with cap).
3. Select [CONFIRM LOADED].

LOADING FLUSH 2

The screen moves to F2 Flush 2, highlighting the text and outlining the bottle.

1. Take a new bottle of the second flush reagent, e.g. alcohol.
2. Put the bottle on top of the Flush 3 bottle, in front of bottle F1 and insert the BLUE reagent tube (with cap).
3. Select [CONFIRM LOADED].

Before loading of dehydrants, the reaction chamber must be flushed, as prompted by the [START] option key displayed. Select [START].

Loading Dehydrants

This involves

- Filling the empty Ex1 bottle with dehydrant at each concentration as highlighted on the Load Reagents screen.
- Transferring the reagent from Ex1 into the reaction chamber and then into the concealed bottle.

Bottle A1 is outlined on the screen.

1. Fill a bottle (between 3.8 L and 5.0 L) with alcohol diluted to 75%.
2. Put the bottle in position Ex1, and insert the BLUE tube (with cap).
3. Select [CONFIRM LOADED] to start the dehydrant reagent transfer.

The next bottle, A2 is outlined on the screen.

Repeat the above steps to load dehydrants A2 - A6.

Load A2 with 90 % alcohol.

Load A3 with 95 % alcohol.

Load A4 - A6 with 100 % alcohol.

Loading Clearants

This involves

- Placing a bottle of clearant in position Ex 2.
- Transferring the reagent from Ex 2 into the reaction chamber and then into the concealed bottle.

If xylene is used as the clearant, X1 Xylene is highlighted and bottle X1 outlined on the screen.

1. Put the bottle of clearant in position Ex2, and insert the RED tube (with cap).
2. Select [CONFIRM LOADED] to start the clearant reagent transfer.

Repeat the above steps to load clearants X 2 and X 3.

When all the clearants are loaded, you are prompted to start a flush cycle to prepare the reaction chamber for use.

To do this, select [START].

When the flush cycle is finished, the screen displays the Instrument Setup menu, and Excelsior ES is ready for use.

- Ensure that you leave an empty bottle in position Ex2, with the RED tube inserted.
- Leave an empty bottle in position Ex1 with the BLUE tube inserted.
- Ensure that you put the caps over the necks of the bottles, to prevent reagent evaporation.

Notes

1. Thermo recommend that you load the reagents in this order so Excelsior ES is fully flushed with the correct reagents.▲
2. Once the instrument is fully loaded, the 'Load Reagents' Menu cannot be accessed again.▲

Loading Fixatives

Fixatives in positions Fix1 and Fix2 are not loaded from the Load Reagents menu. Instead, the Quality Control screen is displayed before the first process run. It will prompt for fixatives to be loaded and [NEW] to be selected for Fix1 and Fix2 (if Fix2 is to be used).

When this happens,

1. Put fixative bottles in positions Fix1 and Fix2, inserting the GREEN reagent tubes fully, together with GREEN caps.
2. Select [NEW].
3. Exit the Quality Control screen.

4. Edit Program

The Program Select screen is displayed below, showing

- Current program titles
- Program duration times, based on the individual step times
- A Notes field, where further information can be entered for display when programs are highlighted.

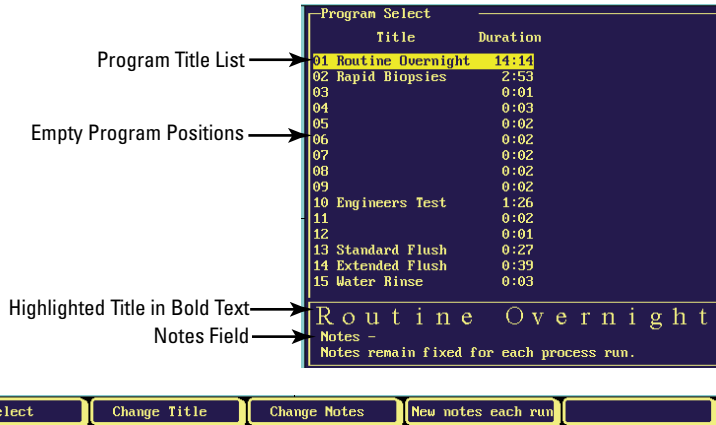

From this screen, you can

- Change Program titles
- Produce all-new, user-defined Program titles
- Add Notes

Changing a Program Title

1. Highlight the title you want to change.
2. Select [CHANGE TITLE] to display a column with pre-defined and user-defined titles.
3. Move down the list to highlight any slot, then select [SELECT].

Producing a User-defined Program Title

1. Highlight a user-defined slot in the program title list.
2. Select [CHANGE TITLE] to display the QWERTY keyboard.
3. Follow the procedure on page 43 to enter the new title, and press **EXIT** to enter the Define Program screen.

Adding Notes

From the Program Select screen, select [CHANGE NOTES] - the QWERTY keyboard is displayed.

Using the text entry procedure (see page 43), enter the text to appear whenever the Program Select screen for that title is displayed.

Select [NEW NOTES EACH RUN] to prompt the operator to add notes at the start of every process run which uses the highlighted program.

Note

If this is selected, the QWERTY keyboard is displayed before the start of every process run, and must be cleared before processing can start. ▲

Select [FIXED NOTES] to display the same text in the Notes field.

Defining Programs

Highlight a program title, and choose [SELECT] to display the Define Program screen, with program steps and parameters;

	REAGENT	HOLD / USE	TIME	DRAIN	VACUUM	STIR
Step no.	Reagent Name	Temperature	Process Time	Time to Drain Chamber	Reaction Chamber Vacuum	Basket Contra-rotation

Program steps →

```

Define Program
Program 1 Routine Overnight
Duration 14:14 Fixed notes: Y
Reagent Hold/Use Time Drain Vac. Stir
1 Formalin Amb. 0:30 30 Off 5
2 Formalin Amb. 0:30 60 Off 5
3 Alcohol 30° 1:00 30 On 5
4 Alcohol 30° 1:00 30 On 5
5 Alcohol 30° 1:00 30 On 5
6 Alcohol 30° 1:00 30 On 5
7 Alcohol 30° 1:00 30 On 5
8 Alcohol 30° 1:00 60 On 5
9 Xylene 30° 1:00 30 On 5
10 Xylene 30° 1:00 30 On 5
11 Xylene 30° 1:00 120 On 5
12 Max 60° 1:20 120 On 5
13 Max 60° 1:20 120 On 5
14 Max 60° 1:20 120 On 5
Use CHANGE REAGENT to select from a Reagent List.
  
```

Change Reagent	Insert Step	Delete Step	Delete All Steps	Copy
----------------	-------------	-------------	------------------	------

- A program can have between 1 and 17 steps.

To create new programs, the suggested sequence is

1. Move to an empty slot in the Program Select screen, and produce a new Program title.
2. Move to the Define Program screen, and highlight your new program. Select [COPY].

This displays the list of defined programs, from which you can copy the steps. Choose a program with similar steps to your requirements.

You now have a new program title, complete with steps, which you can change as required. Additional steps can be inserted or steps deleted.

Changing Program Step Parameters

To change the step information,

- Highlight a step.
- The reagent bottle position for the step is highlighted, and the bottle outlined.
- When the Reagent column is highlighted, select [CHANGE REAGENT] to change either the reagent name or the location to be used for that step.

Hold / Use

The 'Hold/Use' column shows the temperature for each reagent in its storage location and when in use in the reaction chamber.

The 'Hold' temperature for concealed reagents and wax can be changed in the Instrument Setup Menu - Define Reagent Groups option.

The 'Use' temperature can be entered here using the keypad.

Time

The 'Time' column shows hours and minutes for each processing step - the maximum is 99:59.

Highlight the time and change by entering a number with the number keys.

Notes

1. The time to transfer reagents is included in this time. Steps should be at least 3 minutes long. If a shorter step is entered, and fluid transfers take longer than 3 minutes, then the program will overrun its expected end time. ▲
2. The first wax step in any program should be at least 30 minutes long in order to minimise wax carry-over on the reaction chamber walls, and to allow the level sensors to warm up to the wax temperature.▲
3. The 'Drain' column shows a time in seconds to allow the specimens to drain before moving to the next processing step.

Vac The 'Vac' column controls the pressure in the reaction chamber during each step.

Select:

- [VACUUM ON] to process at approximately 650 mBar absolute (350 mBar below atmospheric pressure)
- [VACUUM OFF] to process at atmospheric pressure
- [VACUUM CYCLING] for a pressure increase / decrease cycle every 15 minutes.

Stir The 'Stir' column controls the Contra-stir rotation.

Note

Select Stir setting 3 for the equivalent of Thermo Shandon Pathcentre® Contra stir. ▲

Copying Step Parameters

1. From the Define Program screen, Select [COPY] to display the list of defined programs.
2. Highlight the required program from the list. When the correct program is highlighted, select [COPY NOW].

Select [RESTORE DEFAULTS] to restore the original factory programs. This eliminates any user-defined programs and changes to the default programs

5. Customisation

The customisation screen is shown below, and use of the setup options described.

```
Customisation
Hospital Name      :
Laboratory Name   :
Shift start       06:00
Shift end         18:00
Cassette Counting On      Limit 00000
Level Key available in Daily Operations : Off
Restart Level     : On
On Hold Alarm     : 29 Minutes
Process Start Selection Options
Daytime Program   2  Rapid Biopsies
Available until   18:00
Overnight Program 1  Routine Overnight
Preferred End Time 06:00
Working week      6 days
```

Hospital and Laboratory Name

Select [HOSPITAL NAME] to display the QWERTY keyboard.

Follow the text entry procedure described on page 43 and press **EXIT** when the name is complete.

Repeat for [LABORATORY NAME]. The text is now displayed at the top of the screen.

Shift Start and End

Considering that Excelsior ES should be powered ON at all times, entering details here switches the screensaver ON (displaying a blank screen) at times when Excelsior ES is left unattended.

Cassette Counting

Select [ON] to enable the cassette counting feature. Excelsior ES prompts you to enter numbers as you add cassettes to the reaction chamber - the instrument does NOT count the cassettes.

Level Key Available in Daily Operations

In Daily Operations mode, a [LEVEL] option key is displayed when the reaction chamber lid is opened.

Select [OFF] to remove the [LEVEL] option from the Daily Operations mode.

For all processing, the reaction chamber is filled to the random basket level.

The [LEVEL] key is ALWAYS enabled in Menu Mode.

Restart level

If you select [ON], whenever the reaction chamber lid is opened during processing, Excelsior ES assumes that tissues have been added for processing and fills the chamber to the random basket level. The table below summarises the fill level in the chamber after a restart.

	Level ON	Level OFF
Restart Level	Random	Random
ON	Random	Random
OFF	Level	Random

On Hold Alarm

The number of minutes a process can be left on hold before an alarm is sounded.

Enter a number between 1 and 30 minutes.

Process Start Selection Options

When you open the lid, the currently available program is always displayed.

Process Start selection options, below, let you choose different programs for daytime and overnight processing.

Daytime Program

The program used during the day. Select from the program list displayed.

Available Until

The latest time Excelsior ES will offer the daytime program. Use the number keys to enter the time for Excelsior ES to stop displaying daytime programs.

[NONE SELECTED] - You can choose not to have a daytime program appear when the lid is opened.

Overnight Program The program to be used overnight.
Select from the program list displayed.

Preferred End Time The preferred time for the overnight program to end.
Enter the required time with the number key.

Note

[NONE SELECTED] cannot be chosen for both Daytime and Overnight programs.▲

Working Week Whether the working week is 5, 6 or 7 days. Consider the working week to start on a Monday.
Select the option required.

When all the information is correct, press to return to the previous screen.

6. Reagent Management

This section sets the 'trigger' for reagent rotation and automatic display of the Quality Control screen at the start of a process.

This is for Excelsior ES to inform the operator:

- The defined reagent usage limit has been reached
- They should rotate reagents.

The Rotation Management default setting is shown below.

3 Reagent groups triggered to prompt for rotation by alcohol quality in A1 →

```

Instrument Setup Menu
-----
For initial setup complete sections 1-6 :
1. Set Clock.
2. Define Reagent Groups.
3. Load Reagent Groups.
4. Edit Program.
5. Customisation.

Rotation Management
-----
Reagent Group   Alcohol   Xylene   Wax
Rotation Mode   PROMPT   PROMPT   PROMPT
A1 Quality      Rotate   Rotate   Rotate
Reagent usage   A1       00       X1       00       U1       00
Limits
Sunday
Monday
Tuesday
Wednesday
Thursday
Friday
Saturday
  
```

Arrow across settings →

- You scroll up and down the rotation modes.
- Scroll across to display rotation options for a reagent group.
- When the alcohol quality falls below the set level, the Quality Control screen is displayed before you start processing, and you are prompted to rotate reagents.
- To use reagent counting, enter a number under Rotation Usage Limits to trigger prompting from process counts.
- Highlight a day of the week if you want to rotate reagents according to the day selected.
- It is possible to set more than one trigger, but for correct use of the system you should only set Excelsior ES for one of the rotation trigger options.

7. Concept Demonstration

The concept demonstration shows you reagent movements during tasks performed with Excelsior ES, including

- Loading reagents
- Processing
- Flushing
- Reagent rotation
- Unloading of reagents

When the demonstration is running the screen background is pink and the Demo icon is displayed, to indicate clearly that no real processing is being shown.

You can watch the demonstration at any time, even during processing. Fast Forward and Fast Fast Forward options let you speed up the demonstration.

To exit the demonstration, press [*] on the keypad.

8. Daily Operations

This takes you to Daily Operations mode. If the instrument has been set up with an access code for Menu Mode, this has to be entered to return to Menu Mode.

9. Unload Reagent Groups

- The Unload screen is only available when reagents have already been loaded into Excelsior ES.
- Follow the instructions on the Unload screen and ensure the waste wax tray is correctly fitted.
- Select [UNLOAD] to pump the wax from the selected wax bath into the reaction chamber and then discard it into the waste wax tray.
- Repeat this process for the other wax baths.
- When the last wax has been unloaded, the screen instructions will prompt you to select [START] for a flush run.

- This will remove any remaining wax from the reaction chamber.
- The unload procedure will continue by highlighting the current clearant bottle and the Ex 2 position bottle.
- Confirm that bottle Ex 2 is empty and select [UNLOAD] to continue to remove the reagents.
- Remove bottle Ex 2 and dispose of in accordance with local procedures and regulations.
- Place another empty bottle in the Ex 2 position and follow the screen instructions to remove the remaining clearant reagents.
- When the last clearant reagent has been unloaded, the screen instructions will prompt you to select [START] for another flush run.
- This will remove any remaining clearant reagent from the reaction chamber.
- Remove the F1 and F2 bottles from the cabinet, and select [UNLOADED].
- Dispose of the waste reagent in accordance with local procedures and regulations.
- Start another flush using the water in F3.
- Remove the Fix 1 and Fix 2 bottles from the cabinet and select [UNLOADED].
- Dispose of waste reagents in accordance with local procedures and regulations.
- The unload procedure will continue by highlighting the current dehydrant bottle and the Ex 1 position bottle.

- Follow the screen instructions to confirm that the bottle Ex1 is empty. Press [UNLOAD] to continue to remove the reagents.
- Remove the Ex 1 bottle and dispose of in accordance with local procedures and regulations.
- Place another empty bottle in the Ex 1 position and follow the screen instructions to remove the remaining dehydrants.
- When the last dehydrant has been unloaded, the screen returns to the Instrument Setup menu.

Chapter 4 Menu Mode

Introduction

The Menu Mode screen is shown below. This chapter contains:

- Processing in Menu Mode
- Using the Quality Control screen
- Replacing fixative and flush reagents
- Reagent Rotation - replacing wax and concealed reagents
- Options
- Reagent and Wax checks - using the Inspect feature

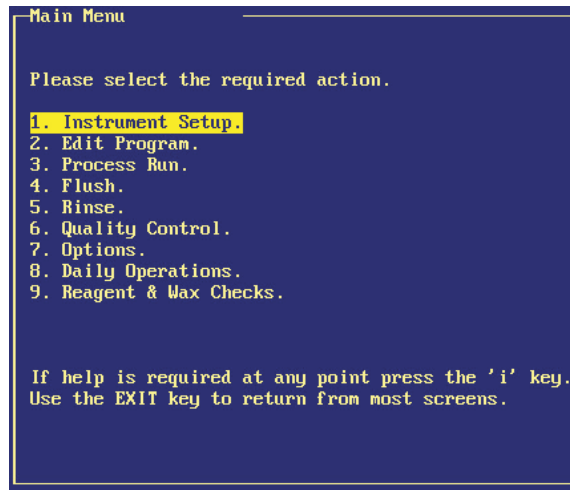

Processing in Menu Mode

Processing in Menu Mode is the same as for Daily Operations, with the exception that the [LEVEL] key option is permanently enabled.

Procedures are given below, with reference to selection of the [LEVEL] key, where appropriate.

Starting the Current Process

1. Open the reaction chamber - push the knob and lift the lid to display the red status screen.

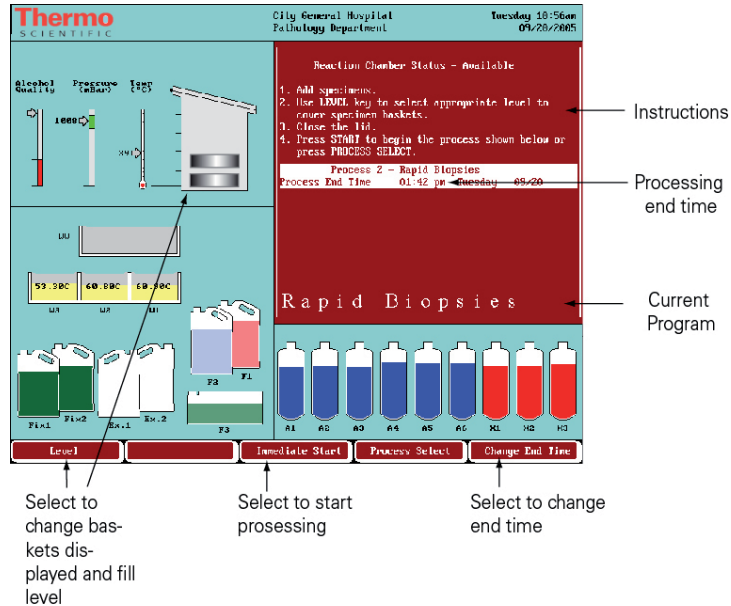

2. Load baskets (with a basket-lid) into the chamber, stacked in uniform pairs, and aligned so they sit properly on the agitation drive pins.

3. Close the reaction chamber lid, pushing down on both sides of the knob to ensure a good seal.

4. Select [LEVEL] once for each pair of organised baskets, up to three times for three pairs of baskets. Select [LEVEL] four times for a random basket. Ensure that the screen shows the baskets you put in the chamber. If too many baskets are shown, press the [LEVEL] key until the display is correct.

If you do not select [LEVEL], Excelsior ES assumes a random basket and fills the chamber to the highest level.

Select [IMMEDIATE START] or [DELAYED START], according to the current program, for daytime or overnight processing.

Monitoring the Process Start

The monitoring screen is displayed, shown below.

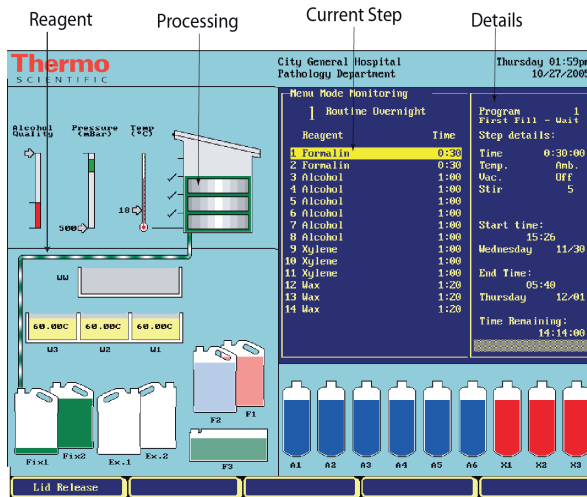

The status is shown as 'First Fill - Wait'.

Ensure that:

- The first reagent is drawn into the reaction chamber, and the status line changes
- The monitoring screen shows that the chamber is filled to the correct level.
- The baskets are completely covered with reagent.

Starting a Different Process

1. Select [PROCESS SELECT] to display the Process Select screen.
2. Highlight the program you want, and check that the End Time is correct.
3. Select [IMMEDIATE START] or [DELAYED START].

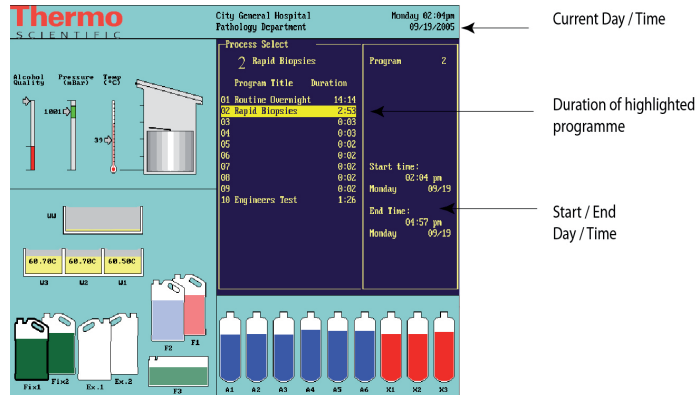

Changing the End Time

1. Select [CHANGE END TIME].
2. Select [SET END TIME].
3. Enter the time with the number keys and use the AM / PM key if necessary. Ensure that End Time and Process are correct.
4. Select [DELAYED START].

Changing the End Day

1. Select [CHANGE END TIME] to highlight the time.
2. Select [SET END TIME].
3. Select [NEXT DAY] on the menu and press the key until Day and Date are correct.
If you press too many times and go past the day you need, you can select [PREVIOUS DAY].
You can set Day and Date up to seven days in advance.
4. When End Time and Day are correct, select [DELAYED START].

Adding Specimens After Starting Process

You can add tissue cassettes after a process has started;

1. Select [LID RELEASE].
Wait for the downdraft fan to start and for the vacuum to release, if the step uses vacuum.
2. Open the lid, add cassettes or baskets, and then close the lid. Follow either 3a or 3b below.

No Baskets Added

- 3a. In the event that you do not add more baskets or are using a random basket, simply select [RESTART]
This continues processing to the original fill level.

Baskets Added

- 3b. If you do add additional baskets use the [LEVEL] key accordingly, so that the basket level shown on the screen corresponds with the baskets in the chamber.
Then select [REFILL AND RESTART].

Aborting a Process

From the monitoring screen,

1. Select [STOP].
2. Select [ABORT].
The process is stopped and the reaction chamber drains.

When Processing is Complete

The status line on the monitoring screen displays 'Process Complete'. You have to:

- Drain the reaction chamber
- Remove baskets
- Wipe away excess wax from the chamber, lid and seal
- Flush and rinse the chamber

Removing Specimens

1. Select [DRAIN ALL CHAMBER] and wait till draining stops.
2. Open the lid and remove basket(s).
If baskets are still shown in the chamber, press the [LEVEL] key to clear them.
3. Wipe out the reaction chamber.

You can remove baskets a level at a time after infiltration:

1. Select [DRAIN NEXT LEVEL] and wait till draining stops
2. Open the lid and remove basket (s).
3. Press [LEVEL] so the screen shows the number of baskets in the chamber. Repeat steps 1 - 3 until the chamber is empty.
4. Wipe out the reaction chamber.

Flushing and Rinsing the Reaction Chamber

When the screen shows there are no more baskets in the chamber, the Flush screen appears automatically - you are required to flush the wax in the reaction chamber before starting the next process.

1. Put empty basket(s) back in the reaction chamber, and close the lid.
2. From the displayed Flush screen, select [START]. *For a different Flush program, select [SELECT FLUSH].*
3. When the monitoring screen shows the Flush program has finished, remove basket (s).
4. Select [OK].

Excelsior ES is ready to start a new process run.

About the Quality Control Screen

Press [QUALITY CONTROL] to display the Quality Control screen, below. It shows;

- Count - number of times reagents and filters have been used
- Limit - the number of uses before alerts are displayed
- Arrows - indicated items have reached limits
- Rotation information - Rotation/Discard due or Will Not Rotate/Discard

Position	Reagents	Count	Usage Limit
Quality Control / Rotation Checklist			
		Count	Limit
Fix1	Formalin	8	7 <
Fix2	Formalin	5	5
Control All Groups			
A1	Alcohol	10	0% used
	Will not rotate next run		
X1	Xylene	8	
	Will not rotate next run		
W1	Wax	8	
	Will not discard next run		
F1	Flush 1	4	5
F2	Flush 2	4	5
F3	Flush 3	4	5
	Downdraft filter	14	13 <
	Exhaustive filter	203	133
	Charcoal filter	133	133

Setting Usage Limits

For Fix1, Fix2, Fix3, F1, F2, F3, the limit is based on counts only.

The limits are set in the Quality Control screen, when in Menu Mode.

For filters, the counts are displayed in weeks.

For A1, X1 and W1 the limit can be based on:

- Specific Gravity
- Usage counts

- Day of the week

The limit is set from Instrument Setup / Rotation Management - see page 56.

Control All Groups

This refers to the rotation of dehydrants, clearants and infiltrants. If these reagents reach their usage limits at the same time, the Control All Groups line is highlighted, showing that this feature is available, and you can rotate the three reagent groups together.

Quality Control and Yellow Triangle Alerts

For fixative and flush reagents, when the usage limit is reached, a yellow triangle is displayed in the reagent bottle and at the top of the screen.

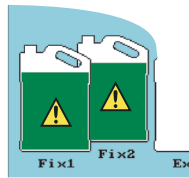

When the usage limit is reached for filters an alert triangle is displayed at the top of the screen only.

- For dehydrants, clearants, and infiltrants (wax), the Quality Control screen is displayed automatically at the beginning of a process run. If alcohol quality at bottle A1 is set as the trigger for rotation, a triangle is displayed above the alcohol quality gauge.

Replacing Fixative Reagents - Fix1-2

When you see the yellow warning triangle alert inside fixative and flush reagent bottles, you should change the reagents before running the next process. Open the lower doors - the Quality Control screen appears. Then:

1. Remove the reagents and 'tell' Excelsior ES.
 - a. Take out the Fix1 and Fix2 bottles and discard them.
 - b. Highlight Fix1 and select [REMOVE].

- c. Highlight Fix2 and select [REMOVE].
2. Place the new reagents and 'tell' Excelsior ES.
 - a. Put new bottles of fixative in positions Fix1 and Fix2.
 - b. Highlight Fix2 and select [NEW].
 - c. Highlight Fix1 and select [NEW].

This zeroes the Quality Control counter, and removes the warning triangles from the screen.

Replacing Fixative Reagents - Fix1-3

Open the lower doors and remove flush reagents in the order F2, F1, F3. In the Quality Control screen:

1. Highlight F2 and select [REMOVE].
2. Repeat for F1 and F3.
3. Place the new reagents in positions F3, F1, F2. In the Quality Control screen, highlight each reagent in turn, and select [NEW].

Reagent Rotation - Overview

Excelsior ES rotation is a unique in-process system for maintaining dehydrants, clearants and infiltrants.

- Excelsior ES discards the used reagent from the appropriate containers (used for the first steps in these processing groups).
- Excelsior ES rotates the rest of the reagents.
- Excelsior ES uses the fresh reagents in the last step for those process groups which have been rotated.

Reagent Rotation - Example 1

An example procedure is described here -the feature ‘Control All Groups’ in the Quality Control screen enables alcohol in A1, xylene in X1, and wax in W1 to be replaced together.

The timeline assumes a schedule of one process run per day.

DAY 1

The alcohol quality has reached its defined limit and a triangle is displayed above the alcohol quality indicator. The Quality Control screen is displayed automatically when the next processing run is due to begin.

- 1 a. In the Quality Control screen highlight the text ‘Control All Groups’.
The text below alcohol and xylene is - ‘Rotation Due next Run’. The text below wax is - ‘Discard Due next Run’.
The selection key options are [ACKNOWLEDGE ALL] and [POSTPONE ALL].
Select [ACKNOWLEDGE ALL].
2. Open the doors to ensure that containers Ex1, Ex2 and WW are empty (waste wax tray WW should have a liner).
3. Run your next process to continue with the rotation.

Excelsior ES uses reagents as usual from A1, X1 and W1, discarding them into the exchange positions (and the waste wax tray).

After the process steps using reagents A2, X2 and W2, these are not returned to these positions - they are moved forward by one position and become the new reagents for A1, X1 and W1. This continues for all subsequent reagents.

DAY 2

The next morning, the screen indicates A6, X3, and W3 are empty, whilst Ex1, Ex2 and WW are full as shown.

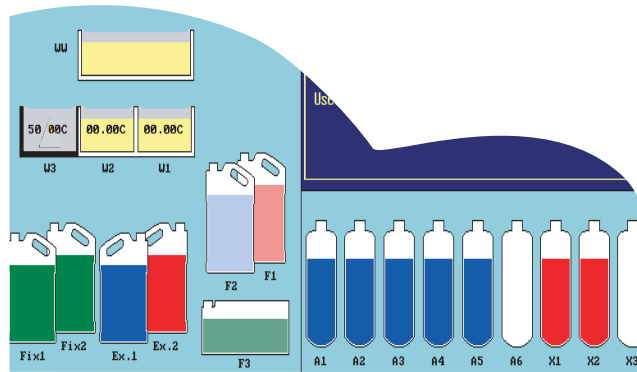

1. Replace the Wax

- a. Open the cabinet doors, and take out the waste wax tray WW. The Quality Control screen appears.
- b. Take the second waste wax tray WW supplied with the instrument, and put it, with a new liner, back in the cabinet.

In the Quality Control screen, highlight WW and select [CONFIRM EMPTY].

- c. Add paraffin wax pellets to the empty wax bath W3. Highlight wax, and select [START HEATING]. While the wax is heating, go to 2 below.

2. Replace alcohol and xylene.

- a. Take out containers Ex1 (waste alcohol) and Ex2 (waste xylene) and dispose of them.
- b. Place fresh 100 % alcohol and fresh xylene into positions Ex1 and Ex2.

In the Quality Control screen highlight the text under alcohol and select [NEW]. Highlight the text under xylene and select [NEW].

3. Transfer reagents to concealed bottles.

Before continuing, ensure that the wax level is correct. Running your next process completes the reagent rotation.

Reagent Rotation - Example 2 Control All Groups

Examples of reagent rotation procedures are described here, for rotating reagents as directed by the Quality Control screen. The timeline assumes a schedule of one process run per day.

DAY 1

The alcohol quality has reached its defined limit and a triangle is displayed above the alcohol quality indicator. The Quality Control screen is displayed automatically when the next processing run is due to begin. It shows that alcohol and wax have reached the usage limit, but xylene has not.

In the Quality Control screen.

The text below alcohol is 'Rotation Due next Run'.

The text below xylene is - 'Will not Rotate next Run'.

The text below wax is - 'Discard Due next Run'.

- 1 a. *Highlight alcohol and select [ACKNOWLEDGE]*
b. *Highlight wax and select [ACKNOWLEDGE]*
2. Open the doors to ensure that containers Ex1 and WW are empty (waste wax tray WW should have a liner).
3. Run your next process.

Excelsior ES uses reagents as usual from A1 and W1, discarding them into the exchange positions (and the waste wax tray). After the process steps using reagents A2 and W2, these are not returned to these positions - they are moved forward by one position and become the new reagents for A1 and W1. This continues for all subsequent reagents.

DAY 2

The next morning, the screen indicates A6 and W3 are empty, whilst Ex 1 and WW are full as shown.

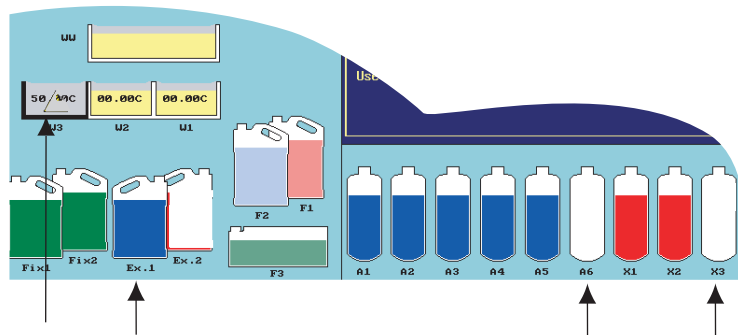

Empty exchange containers

1. Replace the wax.
 - a. Open the cabinet doors, and take out the waste wax tray WW. The Quality Control screen appears.
 - b. Take the second waste wax tray WW supplied with the instrument and put it, with a new liner, back in the cabinet. In the Quality Control screen, highlight WW and select [Confirm Empty].
 - c. Add paraffin wax pellets to the empty wax bath W3. Highlight wax, and select [START HEATING]. While the wax is heating, go to 2 below.
2. Replace alcohol.
 - a. Take out container Ex1 (waste alcohol) and dispose of.
 - b. Place fresh 100 % alcohol into position Ex1. In the Quality Control screen highlight the text under alcohol and select [NEW].
3. Before continuing, ensure that the wax level is correct. Running your next process completes the reagent rotation.

7. Options From Main Menu, Select 7. Options, to display the Options Menu screen.

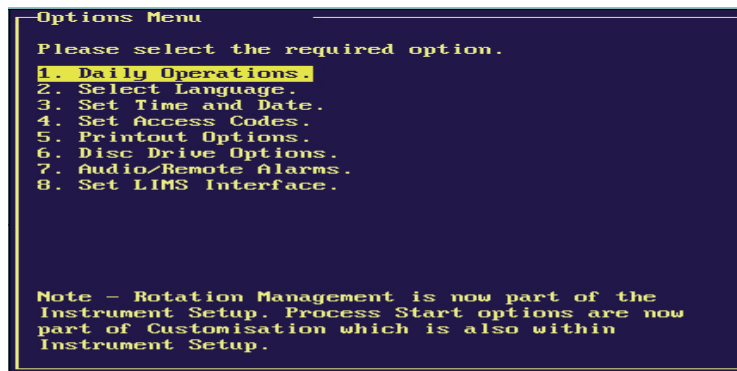

Daily Operations This takes you to Daily Operations mode.

Select Language Highlight the language you want and select [SELECT].

Set Time and Date Sets Time and Date as in Chapter 3, Instrument Setup.

The Access Codes screen is shown below.

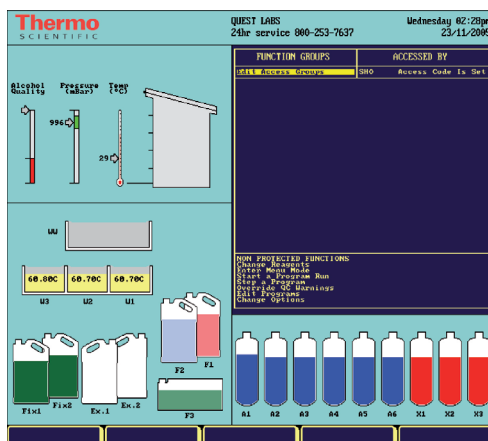

With no functions protected, operators can move between menus and options without restriction.

Access Code protection is available for the following functions;

- Change reagents
- Enter Menu mode
- Start a program run
- Step a program
- Override QC warnings
- Edit programs
- Change options

You have to

- Use [PROMOTE] to move and prioritise functions.
- Use [ADD USER] to assign users to the functions

The first function - 'Edit Access Groups' - is assigned to the default user name - Admin. This is the Administrator. The name can be changed using [CHANGE NAME]

Administrator Access Code

To set the access code for the Administrator

1. Highlight Admin - Access code not set
2. Select [SET ACCESS CODE].
- 3a. Enter a four digit code number, and press **ENTER**
- 3b. Enter the code again, and press **ENTER**

You can set Access Codes for different users, to define who can perform different functions with Excelsior ES.

To change the access code groups,
Enter the Administrator access code on the number keys.
You can now set up to 7 user groups.

Adding Users to a Group

To add a user to a group:

1. Use the arrow buttons to move the cursor to the group.
2. Select [ADD USER].
3. The QWERTY keyboard is displayed - enter the new user name. The name can have up to 5 characters.
4. Select [EXIT] after entering the name to return to the access code screen - the new user is now in the group.

For this user, the Administrator can promote, demote, change name, change access code or delete.

To change the access code:

Highlight the user you want to change, and select [CHANGE ACCESS CODE]. Follow the on screen instructions (same as admin change access code) and press [ENTER].

To delete a user, select [DEMOTE] to move the user to the lowest user defined group, and then select [DELETE USER].

A user has access to the functions of their group and the groups below.

To enable access codes when the set up is complete press *

Printout Options

The Printout Options screen is shown. You can print

- Hard copies to a printer
- To the Excelsior ES screen
- To the Excelsior ES disc drive

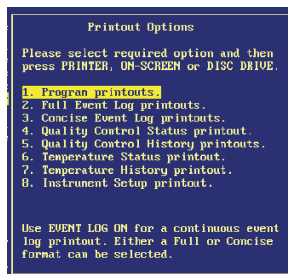

1. Highlight the information you want to print.
2. Select a destination from the key options.

Electrical connections for a printer are detailed in chapter 5 Installing Excelsior ES.

Disc Drive Options

The Disc Drive Options screen is shown.

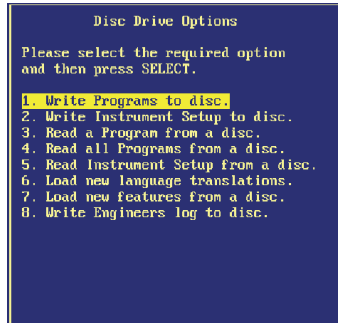

1. Highlight an option in From the list.
2. Insert a floppy disc into the disc drive.
3. Select [SELECT].

Excelsior ES can save programs and instrument setup information on standard 3.5” floppy discs. New languages and features can also be loaded.

Audio / Remote Alarms

The Audio / Remote Alarms screen is shown with default settings.

Event	Sound	Repeat	On/Off
Song recorded	Short Bliip	0	Off/Off
Power On	Power On Horn	0	Off/Off
Program End	Error notes	0	Off/Off
Flash end	No Sound	0	Off/Off
MC cassette count	Rising notes	0	Off/Off
MC program error	3 slow notes	0	Off/Off
MC cannot start	4 fast notes	0	Off/Off
MC tape alarm	5 fast notes	0	Off/Off
Underfill error	Falling notes	0	Off/Off
Lid open in run	2 slow notes	0	Off/Off
Lid left open	3 Fast notes	0	Off/Off
Instrument missing	Fast notes	0	Off/Off
Instrument Fault	5 Fast notes	Cont.	Off/Off
Motor Fail	5 fast notes	0	Off/Off



The screen shows events monitored by Excelsior ES, which can trigger alarms, alerting operators to act, and ensure processing quality. To change settings,

1. Highlight an event.
2. Select from the sounding options: Use the number keys for repeated sounds or [CONTINUOUS] to sound the alarm until it is silenced with the  button on the keypad.
3. For the remote alarm, highlight under RA1 and RA2 and select either [OFF] or [ON].

Different tunes can be selected to play for each event. Both remote alarms can be selected and operated for any combination of events.

External circuits should only be connected to the Remote Alarm socket by a technically competent person. The external circuit should comply with the requirements of IEC1010-1 and or IEC950.

Set LIMS Interface

Excelsior ES can send messages via the serial D-connector, to report events listed on the LIMS screen.

Reagent and Wax Checks

Use this option to bring any concealed reagent or wax into the reaction chamber, outside of processing. The Reagent and Wax Inspection Screen is shown.

Select [DISCARD REAGENT] to discard the reagent. Screen instructions prompt you to place an empty bottle in position Ex1 or Ex2.

Select [CONFIRM EMPTY]. The reagent in the reaction chamber is drained into the empty bottle. Discard the used reagent in accordance with local procedures and regulations.

When the reaction chamber is empty,

- The screen highlights the empty bottle
- The option [LOAD REAGENT] is shown.

To load a new reagent,

1. Place a new reagent bottle in position Ex1 or Ex2, and highlight the empty bottle.
2. Select [LOAD REAGENT] and follow the screen instructions.

Using Inspect to Rotate a Reagent

You can also rotate a reagent into an empty concealed reagent bottle by inspecting the reagent in the next concealed bottle for that reagent group.

When you inspect the next bottle the options include

[RETURN REAGENT],

[DISCARD REAGENT] and

[ROTATE AND RETURN REAGENT]

If you select [ROTATE AND RETURN REAGENT], the reagent is emptied into the original concealed bottle (now empty).

You can then fill that empty bottle with new reagent from the exchange bottle or rotate the reagent from the next concealed bottle. ▲

Note

After inspecting xylene or equivalent reagents, the chamber must be flushed before processing.

Inspecting a Wax

Highlight the relevant wax bath.

Select [INSPECT WAX] to move the wax into the reaction chamber.

Reagent & Wax Inspection Options			
Storage Temp.	Order Used	Loaded Used	Rotated Used
30°C	Alcohol		
	Ex. 1	07/29	0
	A1	07/29	0
	A2	07/29	0
	A3	07/29	0
	A4	07/29	0
	A5	07/29	0
	A6	07/29	0
	Ex. 1	07/29	0
30°C	Xylene		
	Ex. 2	07/29	0
	X1	07/29	0
	X2	07/29	0
	Ex. 2	07/29	0
60°C	Wax		
	W1	07/29	0
	W2	07/29	0
	W3	07/29	0

To return the wax to the wax bath, press [RETURN WAX].

Note

1. The wax must be present for a minimum of 30 minutes in the reaction chamber before returning to the wax bath. ▲
2. If wax is drawn into the reaction chamber, a flush must be run. ▲

To discard all the existing wax and to start again with fresh wax, press [DISCARD ALL] or to discard some of the wax to top up with fresh wax, press [DISCARD SOME].

The screen instructions ask you to confirm that the wax waste tray is empty. Select [CONFIRM LOADED] to drain the wax from the reaction chamber to the wax waste tray. Discard the used wax in accordance with local procedures and regulations.

When the reaction chamber is empty, the screen highlights the empty wax bath and the second key shows [START HEATING].

Pour new wax pellets into the wax tray and press [START HEATING].

Chapter 5 Installing Excelsior ES

Introduction

This chapter includes:

- Unpacking and moving the instrument
- Levelling the instrument
- Connecting the monitor
- Fitting the filters and vent adaptors
- Making mains power connections
- Powering the instrument ON



USE SAFE LIFTING PRACTICES WHEN MOVING Excelsior ES. Excelsior ES WEIGHS APPROXIMATELY 112 kg (246 lb) WHEN EMPTY AND 200 kg (440 lb) WHEN FULL. AT LEAST TWO PEOPLE ARE NEEDED TO SAFELY MOVE THE INSTRUMENT. ▲

Unpacking

Inspect the packaging. If it is damaged, inform your dealer, and inspect the instrument after unpacking.

Remove the banding and lid from the packaging. Follow the instructions on the packing case. Do not discard the packaging - store it flat for future use.

Moving the Instrument when Empty

Fit the transport handles and carefully tilt the instrument back, and push it on the rear wheels. Do not tilt the instrument when it is loaded with reagents.

Moving the Instrument when Loaded

Move the instrument carefully on all four castors.



ALWAYS KEEP THE INSTRUMENT LEVEL WHEN IT IS LOADED WITH WAX AND REAGENTS. MOVE IT SLOWLY TO PREVENT WAX SPILLAGE. ▲

ALWAYS DISCONNECT AND REMOVE THE MONITOR BEFORE THE INSTRUMENT IS MOVED. ▲

Ensure that you have all parts on the packing list.
If parts are missing or broken, contact your dealer.

Notes

1. Quote the instrument Serial Number, your Order Number, Invoice Number, Delivery Note (or Packing Slip) Number and the date.
2. If you need to transport the instrument, refer to Appendix D for repacking instructions.

Levelling the Instrument

Excelsior ES must be level from front to back. Before loading with reagents and wax, ensure that it is fully adjusted.



EXCELSIOR ES WEIGHS APPROXIMATELY 112 kg (246 lb) WHEN EMPTY. WHEN FILLED WITH REAGENTS AND WAX, Excelsior ES WEIGHS 200 kg (440 lb). ▲

Move Excelsior ES to its final position. The floor should be level - the floor and any covering must be non-flammable. There should be at least 95 mm (4 inches) behind the instrument.

To ensure this, leave the transit handles fitted.

Open the reaction chamber lid and remove the dessicant pack from the chamber. Pour 50ml of water into the reaction chamber and use it as a fluid level. When the instrument is level, the water settles evenly at the bottom of the chamber.

If necessary, adjust the front castors. Loosen the locknut (a wrench is provided), then turn the castor with the adjustment rod provided.

When the instrument is level, tighten the locknut.
Mop up the water and dry the reaction chamber.

1. Remove the monitor and base from the packing.
2. Secure the monitor base to the monitor (instruction sheet in accessories box).
3. Place the monitor assembly on top of the instrument.
4. Connect the power and signal cables between the monitor and the instrument. Secure the D-type signal connector by tightening the screws.



THE MONITOR USES 12V DC VOLTAGE ONLY. DO NOT PLUG THE POWER LEAD INTO ANY OTHER POWER SUPPLY. ▲

ALL ACCESSORIES MUST BE CONNECTED TO EXCELSIOR ES BY TECHNICALLY QUALIFIED PERSONS ONLY. ▲

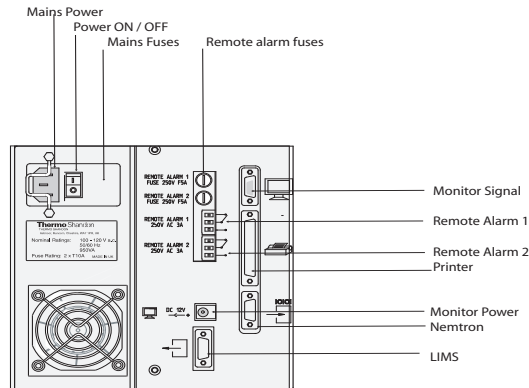

Connecting a Printer

Printers can be connected using the parallel printer port shown on the electrical connections panel. Printers used should comply with IEC950 or IEC1010-1.

Connecting a Remote Alarm

Connections for Remote Alarms 1 and 2 are shown, indicating 'normally open' and 'normally closed' connectors.

Fitting Air Extraction Filters

BOTH EXTRACTION FILTERS MUST BE FITTED.
DO NOT OPERATE THE INSTRUMENT IF EITHER
EXTRACTION FILTER IS NOT FITTED. ▲

FOR CORRECT OPERATION OF THE EXTRACTION
SYSTEM, MAKE SURE THAT THE UPPER AND LOWER
DOORS ARE CLOSED. ▲

Excelsior ES is delivered with new filters fitted into the
instrument. Before using the instrument:

- Remove the filters
- Remove the plastic wrappers
- Replace the filters

The two main extraction filters, separated by a removable metal
baffle, are behind the top door. The upper filter uses potassium
permanganate to extract formalin vapours. The lower filter uses
carbon to extract solvent vapours.

To remove the filters,

1. Open the top door and remove the metal baffle plate.
2. Slide out the filters and remove the plastic wrappers.
3. Replace the filters in the correct positions, so that the airflow
arrow on the filter points up.
4. Replace the baffle plate and close the top door.

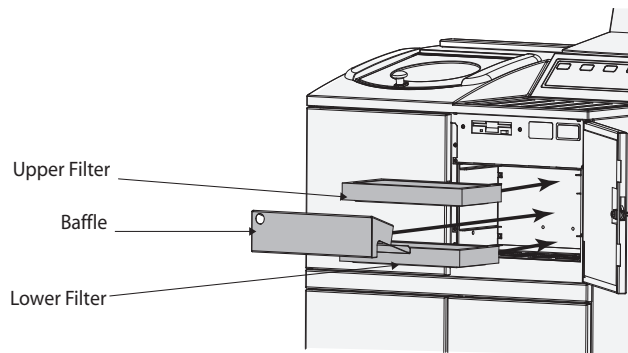

Note

1. The filters fit tightly into their slots for efficient air extraction.

Downdraft Filter

The downdraft filter (potassium permanganate) is at the back of the instrument, behind the reaction chamber.

1. Remove the filter - slide the metal cover up and remove it. Slide the filter up and remove the plastic wrappers.
2. Replace the filter, ensuring that the airflow arrow points away from the instrument.
3. Replace the metal filter cover, locate the bottom of the cover behind the filter and then push the filter cover down and towards the front of the instrument. The cover should be securely positioned on the raised wall.

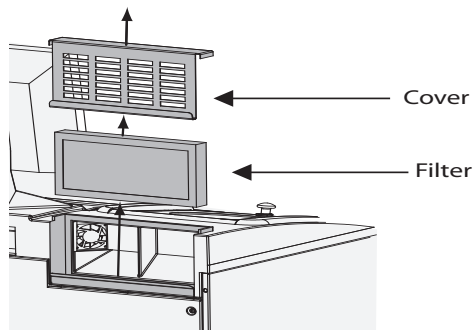

Fitting Optional Vent Adaptors

The optional vent adaptors allow fumes to be extracted into a fume cupboard or hood, or vented to the outside atmosphere.



DO NOT USE THE VENT ADAPTORS TO EXTRACT THE FUMES THROUGH THE BUILDING HVAC SYSTEM OR A COMMON SITE EXTRACTION SYSTEM. ▲

Extraction Vent Adaptor

Fit the vent adaptor to the instrument rear with the fixings supplied. Route the ducting to a vented area.

Do not remove the main extraction filters.

Downdraft Extraction Vent Adaptor

Remove the downdraft filter and the metal filter cover. Fit the downdraft extraction bracket into the filter pocket and press downwards and forward until it is secure.

Route the ducting to a vented area.

Connecting to Mains Power

Ensure that the mains supply voltage corresponds with the voltage rating on the rating plate on the back of the instrument.

Note

1. The \sim symbol on the rating plate indicates that the instrument operates on an alternating current supply (AC).

Ensure that the I / O power switch at the rear of the instrument is switched off (O side of the switch pushed IN).

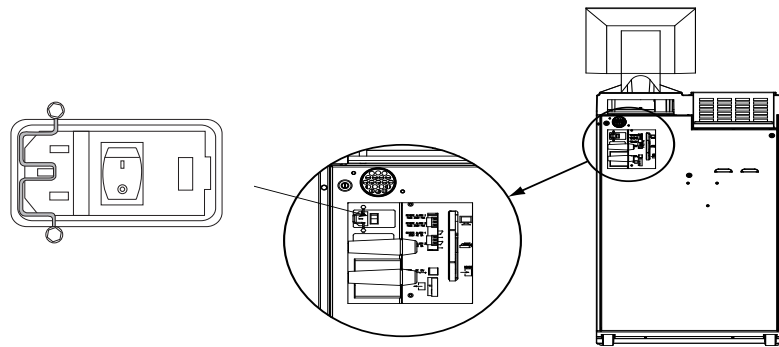

Instruments are supplied with power cords with moulded plugs suitable for many countries. If another plug is required, it is necessary for a technically-competent person to remove the moulded plug from the white power cord (UK-style plug) and fit a suitably rated, fused plug using the wiring convention shown below:

<i>Brown wire:</i>	<i>Live (L or L2) terminal</i>
<i>Blue Wire:</i>	<i>Neutral (N or L1) terminal</i>
<i>Green / yellow wire:</i>	<i>Earth terminal - E, ground or V</i>

Insert the appropriate mains cable into the mains connector on the rear panel of the instrument and clip the cable restraint over the mains connector. Connect the mains supply cable to the local power supply outlet.

EXCELSIOR ES MUST BE ELECTRICALLY EARTHED. MAKE SURE THAT THE INSTRUMENT IS PLUGGED INTO A PROPERLY EARTHED (GROUNDED) MAINS SUPPLY. ▲

IT MUST BE POSSIBLE TO INTERRUPT THE MAINS SUPPLY AT SOURCE BY REMOVING THE PLUG FROM THE MAINS SUPPLY SOCKET. ▲

Powering the Instrument ON

Press the I (ON) side of the I / O power switch.

When Excelsior ES is powered ON, you should notice the following:

1. The cooling fans audibly start, and the instrument LED lamps illuminate.
2. The rotary valve motor audibly starts.
3. After 30 seconds, the language screen is displayed.
Highlight the required language and select [SELECT]

The screen displays the battery isolation switch and heater reset alert icons. The icons must be cleared, before any further operations:

1. Turn ON the battery isolation switch.

2. Press the heater reset switch.

The icons and switches are shown - the inset shows the view inside the cabinet, behind the right door, above the flush reagent bottles.

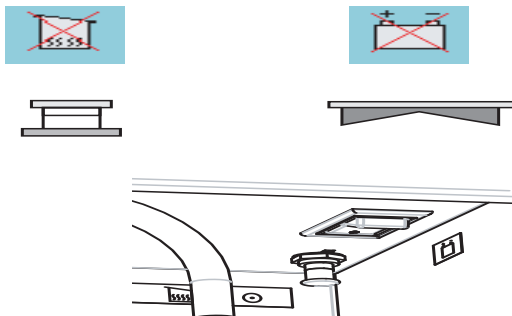

Leave the battery switched on and do not switch it off unless instructed to do so.

Note

1. When the Heater reset switch is set and the Battery Isolation Switch is turned on, the icons will disappear from the display. First battery charging: after switching on both the main I/O power switch and the Battery isolation Switch, the instrument should be left for a period of 14 hours (overnight) to ensure the battery is fully charged.

Standby

For continuous and consistent processing, The instrument should be powered ON at all times.

Press the Standby key [⏻] to turn off the screen and lock the keyboard - processing continues.

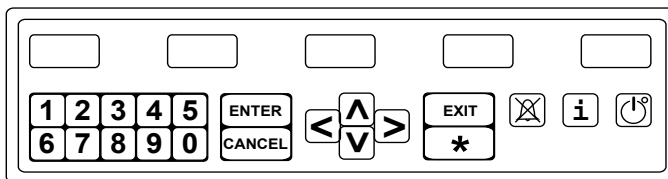

Note

1. The red LED on the Standby button flashes when the instrument is in STANDBY mode.

To unlock the keyboard and turn the screen on, press the  button again.

Powering OFF for extended time

If the instrument is to be left unattended for long periods of time, or is to be moved, carry out the following steps:

1. Ensure that any processing programs have finished. Carry out a Flush procedure.
2. Press the O (OFF) side of the main I/O power switch to switch off Excelsior ES.
3. Wait approximately 45 seconds.
4. Press the O (OFF) side of the Battery Isolation Switch to isolate the battery.

Chapter 6 Troubleshooting

Introduction

The instrument systems place the highest priority on specimen integrity and processing quality. Excelsior ES continually monitors its status, giving clear visual and audible warnings in the event of a problem, and providing extensive specimen safety measures.

- The Thermo logo at the top of the screen is replaced by alert icons, a highly visible indicator of instrument issues. *The Quality Control and Fault Status screens enable quick diagnosis.*
- The rechargeable battery provides backup power if there is a mains power failure.
- A sounding alarm with remote facility can send warnings out of working hours. See page 79 for details.

This chapter contains the following sections;

- The alert icons explained, and procedures to clear them.
- TABLE 1 on page 98 lists apparent instrument malfunctions with possible causes and suggested remedies.
- TABLES 2 and 3 on page 98 list common processing problems, possible causes and suggested actions.
- TABLE 4 on page 102 answers Frequently Asked Questions.

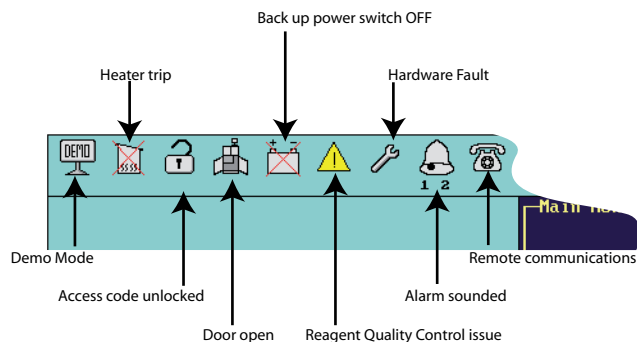



Concept Demonstration program is currently active. The pink screen background shows that the program is not live. Press on the keypad to exit the demonstration.



Reaction Chamber Heater Trip. Processing cannot start. Open the top right cabinet door and press the Reset switch.



Access Codes have been unlocked. The name of the person who has unlocked the codes is displayed underneath the icon. To re-enable Access codes, press on the keypad.



Cabinet Doors Open. This condition brings up the Quality Control screen. Close the lower doors, then press on the keypad to close the Quality Control screen.



Battery Isolation Switch is not on. Open the top right cabinet door and turn the rocker switch ON to restore battery backup and ensure power to the instrument.



Mains Power failure - the instrument is running on battery backup power (% available power displayed). Inspect mains power connections, power cable and mains supply.



Quality Control Alert. Open the Quality Control screen for details.



Hardware Issue. There is a problem with the instrument. Processing cannot start in this condition. Press on the keypad to display the Fault Status screen - see below for details.



Remote Alarm. A remote alarm has sounded. The icon shows whether it is Alarm 1 or Alarm 2. Press on the keypad to silence the alarm.



Netmon Session in progress. Netmon information is being downloaded and the instrument is being checked.

Using the Fault Status Screen

If the wrench icon is displayed , press  on the keypad to display the Fault Status screen, below.

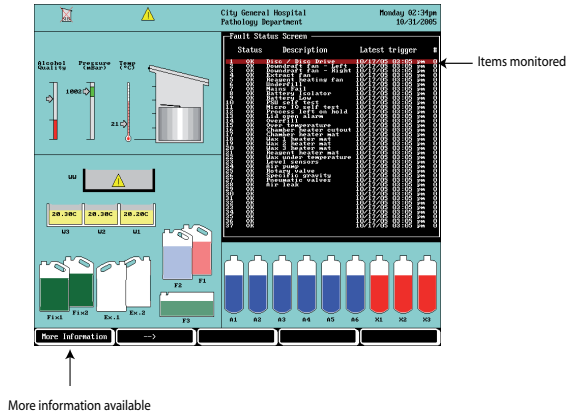

The Fault Status Screen shows the following information;

- A numbered list of monitored items - Description
- Item Status, reported as OK, WARN or FAIL
- The last time each item was monitored - Latest Trigger
- The number of times there is an issue with any item - #

If the status is WARN, you can select [ACKNOWLEDGE].

If the status is FAIL, you can select [RETRY].

These selections clear the alert icon, and you can try to continue processing. If the problem persists, contact your Thermo Distributor.

Underfills and Recovery

Reaction chamber underfill and overflow events are displayed here.



BE AWARE OF SAMPLES USED. THEY MAY POSE A BIOHAZARD.

TABLE 1 INSTRUMENT FUNCTION

SYMPTOM	CAUSE	REMEDY
Excelsior ES does not respond when the mains power is switched on.	The instrument is still carrying out initial tests.	Wait 30 seconds for the initial tests to finish.
	No power supply	Connect the power lead. Switch on the mains power and instrument main power switch.
	The mains fuses have blown.	Replace the mains fuse. Replace the instrument fuses. Note: Only a technically competent person should replace fuses.
Excelsior ES is powered ON, but the screen is blank.	Instrument in Standby, screensaver ON.	Press  on keypad to switch instrument out of Standby.
	The monitor is not connected correctly.	At the back of the instrument, ensure that the power and signal cables are correctly connected.
	The monitor is faulty.	Replace the monitor. Contact your Thermo dealer.
A process is started, but the first reagent is not drawn in.	The lid is not closed.	Open the lid and close by pressing down firmly on either side of the knob; do not use the knob itself to close the lid.
	The lid seal is contaminated with wax.	Clean the seal lid.
After loading reagents, a Process Start screen is not displayed.	The second short flush routine at the end of the load sequence has not been run.	Return to the Load Reagents menu, and complete the sequence.

The process start screen is not displayed and a message requests reagent transfer.	The reaction chamber is empty.	Go to Reagent and Wax Checks [9] and confirm there are no reagent transfers in progress. Inspect a reagent, for example A1, then return it to the bottle.
The QWERTY keyboard is displayed at the start of a run.	You have selected New Notes Each Run on the programme screen	Go to Edit Programme and deselect this option if you don't want it.
An underfill is registered on first transfer, but for no obvious reason.	The lid is not fully closed.	Open and close the lid - press on either side of the knob to close the lid, do not use the knob itself.
	The emergency vacuum release has been removed.	Refit the red vacuum release knob behind the panel, between the two front filters.
An underfill warning occurs for the front reagents, but the bottle is full.	The pipe is not fully intersected in the bottle.	Ensure the pipe reaches to the bottom of the bottle and is not bent or twisted.
Bottles A6 and X3 appear empty.	This is correct - these bottles are empty after a discard run. The reagents from A6 and X3 have been rotated to A2 and X2.	Remove the discarded reagents and replace them with the new 100% alcohol and xylene in the Ex1 and Ex2 positions respectively. After the next run A6 and X3 are filled with new reagents.
The waste wax tray is not registered as fitted, and a warning triangle is displayed	The tray has not been detected.	<ol style="list-style-type: none"> 1. Go to the Quality Control Screen and confirm that the tray has not registered. 2. Find the reagent position. 3. From Main Menu, use Reagent and Wax Checks to correctly fill the reagent bottle.

If there is an instrument malfunction remove ALL specimens from the reaction chamber. If it is necessary to release the chamber vacuum, open the top right door, remove the metal plate and pull the vacuum release knob (see pgs 14-15). Contact Thermo Service.

TABLE 2 PROCESSING PROBLEMS - SOFT, SPONGY TISSUE

SYMPTOMS	POSSIBLE CAUSE	REMEDY
<ul style="list-style-type: none"> • Difficult to section • Section breaks up on the water bath • Poor staining 	Inadequate fixation	<ol style="list-style-type: none"> 1 Increase time in fixative 2 Use microwave enhanced technique 3 Bisect if encapsulated specimen or produce a thinner block. Note that improper fixation cannot be remedied.
<ul style="list-style-type: none"> • Clearing impossible • Discoloured cloudy areas within specimen • Section breaks up on water bath 	Inadequate dehydration	<ol style="list-style-type: none"> 1 Increase time in alcohol 2 Make sure concentration of alcohol is correct 3 Adjust solution rotation schedule 4 Rule out contamination from lipids 5 Bisect if encapsulated specimen or produce a thinner block 6 Reinfiltate in wx. If inadequate, reverse process to absolute alcohol and reprocess.
<ul style="list-style-type: none"> • Wax cannot infiltrate • Discoloured cloudy areas within specimen • Section breaks up on the water bath 	Inadequate cleaning	<ol style="list-style-type: none"> 1 Make sure the specimen is completely dehydrated 2 Adjust rotation schedule 3 Increase time in clearant 4 Use vacuum 5 Bisect if encapsulated specimen or produce a thinner block 6 Reinfiltate in wax. If inadequate, reverse process to absolute alcohol and reprocess.
<ul style="list-style-type: none"> • Can feel or smell clearing solution • No support when sectioned • Section breaks up on the water bath 	Inadequate wax infiltration	<ol style="list-style-type: none"> 1 Extend exposure time 2 Use vacuum 3 Bisect if encapsulated specimen or produce thinner block 4 Reinfiltate. Use vacuum to promote infiltration.

TABLE 3 PROCESSING PROBLEMS - HARD, BRITTLE TISSUE

SYMPTOMS	POSSIBLE CAUSE	REMEDY
Obvious drying of all or part of the specimen	Drying during transport	1 Use the volume of 20:1 in appropriately sized container
<ul style="list-style-type: none"> • Brittle sections that fall out of block • Microchatter 	Excessive dehydration	1 Decrease time and/or steps 2 Check graduated strengths of alcohol 3 Segregate small, delicate specimens 4 Do not use heat and/or vacuum 5 Soak for short time in chilled water, do not trim away hydrated area and section slowly
	Excessive clearing	1 Decrease time and/or steps 2 Evaluate xylene substitutes 3 Segregate small, delicate specimens 4 Do not use heat and/or vacuum 5 Soak for short time in chilled water, do not trim away hydrated area and section slowly
	Excessive heat	1 Reduce processing temperature during reagent steps 2 Decrease time and/or steps 3 Check temperature reading with thermometer 4 Segregate small, delicate specimens 5 Soak for short time in chilled water, do not trim away hydrated area and section slowly.

TABLE 4 FREQUENTLY ASKED QUESTIONS

QUESTION	ANSWER
<p>What is the recommended way to open the lid during a process run?</p>	<p>Select the lid release key and wait until the status message (at the top pg the right hand box, on the monitoring screen) says 'Lid released' before opening the lid.</p> <p>Note: As you have requested an action, you must allow the instrument time to complete it's original activity, and then implement the action. If you don't do this, your subsequent actions might cause you unnecessary problems. On no account simply open the lid, as this causes and alarm.</p>
<p>Why is the minimum time in the first wax bath 30 mins?</p>	<p>The minimum immersion times for the wax baths are:</p> <p>First wax bath - 30 minutes Additional wax steps - 5 minutes each</p> <p>You need to hold the wax in the chamber for sufficient time to heat the surface of the level sensors. If the wax is not hot around the sensor/s then when the wax drains out, a covering of wax will remain over the sensor. The instrument still registers wax up to that level and will therefore keep trying to 'drain' that wax out. 30 minutes is the time it takes to ensure that the level of sensors are all up to temperature.</p>
<p>How can a step be deleted in a programme?</p>	<p>Use the Delete Step key. If you select '0' time in a position, Excelsior ES will still draw the fluid into the reaction chamber and then drain it immediately after entering the chamber.</p>
<p>Where are the keys to change the alcohol quality rotation setting?</p>	<p>From Menu Mode, select Instrument Setup, Rotation Management. Highlight the Alcohol Quality line. Two selection keys [Up] and [Down] are displayed.</p>

Chapter 7 **Cleaning and Maintenance**

Introduction

Normal standards of laboratory hygiene and routine maintenance procedures are all that is necessary to keep Shandon Excelsior ES in good and serviceable condition.



IF HAZARDOUS MATERIAL IS SPILT ON, OR INSIDE, THE INSTRUMENT, YOU MUST CARRY OUT THE APPROPRIATE DECONTAMINATION. ▲



CLEANING OR DECONTAMINATION METHODS, OTHER THAN THOSE RECOMMENDED IN THE OPERATOR GUIDE, SHOULD BE CHECKED WITH A THERMO AGENT TO ENSURE THAT THE PROPOSED METHOD WILL NOT DAMAGE THE EQUIPMENT. ▲

WARNING

ALWAYS WEAR PROTECTIVE GLOVES WHEN YOU CLEAN OR DECONTAMINATE SHANDON EXCELSIOR ES TO PROTECT YOURSELF AGAINST THE EFFECTS OF CHEMICALS. ▲

WARNING

DO NOT USE ANY CHEMICALS THAT MAY INTERACT WITH MATERIALS OF MANUFACTURE. IF IN DOUBT, CHECK WITH THERMO SERVICE DEPARTMENT.▲

WARNING

PHENOL AND HYPOCHLORITES IN STRONG SOLUTION WILL DAMAGE THE INSTRUMENT AND ITS ACCESSORIES. ▲

WARNING

DO NOT USE ABRASIVE COMPOUNDS OR METAL COMPONENTS TO CLEAN SHANDON EXCELSIOR ES OR ITS COMPONENTS AND ACCESSORIES.▲



ALWAYS WIPE UP ANY SPILLS IMMEDIATELY. IN THE EVENT OF A MAJOR SPILLAGE, DISCONNECT THE INSTRUMENT FROM THE MAINS SUPPLY WITHOUT DELAY AND DO NOT RECONNECT AND SWITCH ON UNTIL THE INSTRUMENT HAS BEEN THOROUGHLY DRIED OUT AND CHECKED BY A SERVICE ENGINEER.▲

WARNING

DO NOT USE ACETONE OR BOUIN'S FIXATIVE.

ANY ACCIDENTAL SPILLAGE OF REAGENTS ON THE KEYPAD SHOULD BE REMOVED BY IMMEDIATELY WIPING WITH A CLOTH AND A SMALL AMOUNT OF ALCOHOL.▲

POTENTIALLY LETHAL VOLTAGES ABOVE 110VAC ARE PRESENT INSIDE THE UNIT. DO NOT REMOVE ANY ACCESS COVERS.▲



THE FOLLOWING INSTRUCTIONS ARE THE RECOMMENDATIONS OF THERMO. IF ANOTHER CLEANING METHOD IS REQUIRED, PLEASE CONTACT THERMO.▲



INSPECT THE INSTRUMENT FOR OBVIOUS DAMAGE OR WEAR WHENEVER YOU CLEAN OR USE IT.▲

WARNING

REMOVE THE MAINS PLUG FROM THE SUPPLY SOCKET BEFORE YOU CLEAN THE FIXED COMPONENTS OF THE INSTRUMENT.▲

**Reagent Bottle
Maintenance****WARNING**

USE GLOVES AND SAFETY GLASSES WHEN DEALING WITH REAGENTS.▲

**Fix1, Fix2, Ex1, Ex2
F1, F2 Bottles**

These are the reagent supplier's bottles in the front cabinet. (Note that 2 empty 5 litre bottles are supplied for the Fix 1 and Fix 2 positions).

To remove the bottles, carefully remove the dip tubes from the reagent bottles

and clean any contamination from the surface of the tubes with a lint free cloth.

Remove the bottles from the instrument and replace their caps. Dispose of the used reagent in accordance with your local regulations and procedures.

Flush 3 Water Bottle

The Flush 3 bottle is in the cabinet, below the Flush 1 and Flush 2 bottles.

To remove Flush 3 water bottle, first remove the Flush 1 and Flush 2 bottles. Remove the green reagent tube from the rear of the bottle and carefully lift and slide the bottle out of the Reagent Storage Area. Remove the cap and dispose of the water in accordance with any local procedures and regulations.



KEEP THE FLUSH 3 BOTTLE LEVEL TO AVOID ANY SPILLAGE. ▲

THE FLUSH 3 WATER BOTTLE MUST BE CLEANED BEFORE IT IS REFILLED WITH WATER. ▲

To clean the Flush 3 water bottle, rinse the bottle with clean water and mild detergent. Use a bottle brush if required. ▲



DO NOT USE TEMPERATURES HIGHER THAN 60°C. ▲

Refill the Flush 3 bottle with water to the bottom of its neck and replace the cap. Place the water bottle in the Reagent Storage Area with the cap towards the front of the instrument. Fit the green drain tube into the open pipe at the rear of the Flush 3 Water Bottle.

Make sure the tube is fully inserted into the Water Bottle so that it sits on the bottom of the bottle and that there are no kinks in the flexible section

of tube.



Discarding Used Wax

REFER TO THE MATERIAL SAFETY DATA SHEETS (MSDS) WHEN HANDLING THE REAGENTS LISTED IN APPENDIX C. ▲

When the wax is changed (using the rotation technique, as described), the oldest wax is discarded into the waste wax tray.

Excelsior ES prompts you to confirm that the waste wax tray is in place above the two right hand wax baths.

Fit a waste liner into the waste wax tray and make sure that the top of the liner is folded over the top of the tray. Fit the lid.

To remove the waste wax, open the wax door and carefully slide the waste wax tray from the instrument.



THE WASTE WAX TRAY CONTAINS HOT MOLTEN WAX. KEEP THE TRAY LEVEL AT ALL TIMES. DO NOT REMOVE THE TRAY AND LINER UNTIL THE WAX HAS SET

Place the tray in a cool, well ventilated area away from the instrument and allow to set.

When the waste wax has set, remove the waste bag from the waste wax tray and discard the solid wax in accordance with local procedures and regulations. Keep the waste wax tray safely for reuse.

WARNING

Ensure that there is always a waste wax tray in the instrument with a correctly

fitted liner. A spare waste wax tray is provided.

Slide the tray back into its position above the wax baths and close the access doors.

Cleaning Wax Baths



THE METAL PLATES IN THE BASE OF THE WAX BATHS ARE HOT. ALWAYS WEAR GLOVES.

After the old wax is discarded, Wax Bath 3 is empty (a). Open the left hand wax access door. Use absorbent paper to wipe out any remaining wax from the wax bath. Make sure that no paper is left in the wax bath.

Reaction Chamber

Open the lid and use the plastic spatula provided to remove any solidified wax from the lid, top and sides of the Reaction Chamber. If necessary, wipe the surfaces with absorbent paper and small amount of xylene.

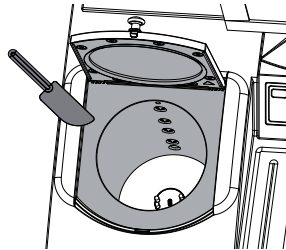

THE LID SEAL AND TOP SURFACE OF THE REACTION CHAMBER MUST BE KEPT CLEAR OF WAX FOR THE INSTRUMENT TO OPERATE CORRECTLY.

THE LID SEAL CANNOT BE REMOVED FOR CLEANING. - DO NOT TRY TO REMOVE IT.

WARNING

Use absorbent paper to wipe out any residual wax from the Reaction Chamber.

Note

1. Flush reagents will last longer if wax is removed from the Chamber and Baskets before a flush is carried out.
2. Use absorbent paper to gently wipe the 4 level sensors in the Reaction Chamber - DO NOT use abrasive cleaners.
3. Do not use metal tools to clean or scrape the reaction chamber.
4. Do not use any chemicals other than those recommended in Appendix C.
5. Do not scrape around the edge of the reaction chamber base (c). If any debris falls into this gap, carefully use tweezers to remove it.
6. Close the Reaction Chamber Lid and perform a flush to rinse the Chamber.

Note

1. Wipe the Reaction Chamber after every flush and check for any contamination. Evidence of wax may indicate that the flush reagents need to be changed.
2. Ensure the instrument is powered OFF. Disconnect the monitor from the instrument. Wipe the monitor gently with a soft damp cloth.

Cleaning the Monitor

WARNING

3. Do not use solvents to clean the monitor.

Changing Filters

Change the filters every 3 months. To replace the filters, follow the instructions in Chapter 5 Installing Excelsior ES.

Spillages

Any reagent spills within the instrument will be contained.

Small spills, such as drips from the reagent tubes when the reagents are changed, will evaporate and be extracted.

To clean large spills, remove all the reagent bottles in the Reagent Storage Area. To access the spillage containment area, lift and remove the metal shelf in the base of the Reagent Storage Area. Clean any liquid from this area and dispose of in accordance with any local procedures or regulations.

Replace the metal shelf and the reagent bottles.

Appendix A Specification and Accessories

Specification

Physical	Width	670 mm	(26½ ins)
	Depth	520 mm	(20½ ins)
	Height to monitor platform	1130 mm	(44½ ins)
	Height to top of monitor	1600 mm	(63 ins)
	Weight with no reagents	112 kg	(246½ lbs)
	Weight with typical reagents	200 kg	(440 lbs)

Electrical	Power Supply Voltages:	100 - 240 VAC (-)
	Frequency	50 / 60 Hz
	Power 950 VA (maximum):	200VA (typical)
	Maximum supply voltage fluctuations not to exceed ± 10% of nominal voltage	

Internal batteries
(Yuasa NP12-12)
12V, 12Ah valve regulated
sealed lead-acid type
rechargeable battery

Interface Connections

Remote Alarm 3A,	240 VAC operation; non powered output;
LIMS	Serial RS232
Netmon	Serial RS232
Printer	Centronics Parallel;

External Remote Alarm and Printer to comply with IEC950 or IEC1010-1

Fuses

Mains plug fuse (where applicable) 13A 250V

Mains input fuses (x 2)

T10A 250V

Remote alarm fuses (x 2)

F 5A 250V

(Fuse spares kit)

A78410028

Note: Fuses should only be replaced by technically competent personnel

Switch Conventions

I Power On

0 Power Off

 Standby

Environment

General Indoor use only

Temperature (operation) +5°C to +40°C

Temperature (transit / storage) -25°C to +55°C (+70°C for short exposure)

Humidity Maximum 80% RH at 31°C
decreasing linearly to 50% RH at 40°C

Altitude up to 2000m (6,500 feet)

Pollution degree 2

Over voltage category II

Thermo Part Number

A78400006

Centre of Gravity Position

Centre of gravity position for a fully laden instrument (see also page 5)

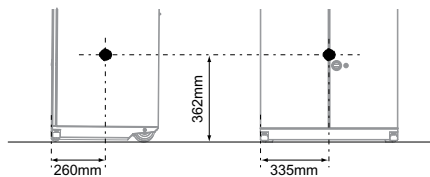

	INSTRUMENT	QUANTITY	PART NUMBER
Accessories Baskets	Organised Basket	6	A78410025
	Random Basket	1	A78410021
	Large Block Metal Divider		
	(for Random Basket)	1	A78420158
	Basket Lid	1	A78420156
	Plastic Basket Carrying Container (microwaveable)	1	B35210007
	Extraction Adaptor Kits	Downdraft Extraction Duct Adaptor Kit	1
Main Air System Duct Adaptor Kit		1	A78410024
Filters		Carbon	1
	Potassium Permanganate Filter	1	9990612
	Potassium Permanganate Filter		Pack of 6B9990612CS
	Monitor	Monitor Clamp	1
Reagent Bottles	5 litre Reagent Bottle	6	A78410026
	Wax Waste Tray Kit, comprising		A78410027
	Wax Waste Tray	1	
	Wax Waste Tray Lid	1	
	Wax Waste Liners	20	AP14747
General	Door Keys	1 set	AP14733
	Operator Guide	1	A78410100
	Screen Information Cards	1 set	A784-1002
	Service Manual	1	A78410101
	Spatula	1	P09046

Reagents

	QUANTITY	PART NUMBER
Wax fill chute	1	A78430265
FORMAL-FIXX		
Concentrate (5x)		
(3.8 litre bottle (makes 19 litres)	1	6764254
Concentrate (5x)		
(1 litre bottle (makes 5 litres)	2	9990244
Ready to use (19 litres / 5 gal)	1	6764240
Pre-filled cups (see catalogue for full details)		
Wrench for 19 litre carboy	1	B1000722
Zinc Formal-Fixx:		
Concentrate (5x)		
(3.8 litre bottle (makes 19 litres)	1	6764255
Ready to use (19 litres / 5 gal)	1	6764250
Wrench for 19 litre carboy	1	B1000722
GLYO-FIXX		
Ready to use (3.8 litres)	1	6764262
Ready to use (19 litres / 5 gal)	1	6764260
Concentrate (5x)		
(3.8 litre bottle (makes 19 litres)	1	6764265
Pre-filled cups (see catalogue for full details)		
Wrench for 19 litre carboy	1	B1000722
SHANDON XYLENE SUBSTITUTE		
Ready to use (4 litres)	1	9990505
Ready to use (4 litres)	4	6764506
Ready to use (10 litres)	2	6764508
Ready to use (19 litres / 5 gal)	1	9990507
Ready to use (209 litres /55 gal)	1	9990509
Wrench for 19 litre carboy	1	B1000722
PARAFFIN WAX		
Histoplast (10 kg bag)	1	6774060
Histoplast (2.5 kg box)	1	6774006
Paraplast® (1 kg bag)	8	501006
Paraplast® Plus (1 kg bag)	8	502004

Paraplast® X-tra (1 kg bag) 8 503002

A full range of reagents and cassettes is listed in the Thermo catalogue.

Formal-Fixx™ Glyo-Fixx™ and HistoSolve Adobe Garamond Pro are trademarks of Thermo Scientific;

Paraplast® is a registered trademark of Sherwood Medical;

Peel-A-Way® is a registered trademark of Polysciences.

Declaration of Conformity

This Declaration of Conformity is only valid when the instrument is used in accordance with the Operator Guide A78410120

Manufacturer's Name: Thermo Shandon Limited (Trading as Thermo Fisher Scientific)
Manufacturer's Address: Chadwick Road, Astmoor, Runcorn,
Cheshire, WA7 1PR
ENGLAND

Product Description: Enclosed Tissue Processor
Product Designation: **Shandon Excelsior ES™**
Part numbers: A78400006
including accessories supplied as standard

Year of Marking (CE): 2002

This product conforms with the essential requirements of the following directives:

In Vitro Diagnostics Directive 98/79/EC
Low Voltage Directive 2006/95/EC

This product complies with the following International Standards:

EMC: EN 61326:1997 Inc A1:1998
EN 61000-3-2:2001
EN 61000-3-3:1995

Safety: IEC 61010-1:1993 Inc A2:1995
EN 61010-2-010:1994 Inc A1:1996
CAN/CSA C22.2 No. 1010.1-92 Inc A2:1997
UL Std No. 61010A-1

Issued by: K. Waldron
Quality Manager
Thermo Fisher Scientific
Anatomical Pathology, Diagnostics Division



Date: 27th April 2007

Optional accessories considered subject to the In Vitro Diagnostics Directive (IVDD) are specifically identified on this Declaration of Conformity. Further supplies of standard accessories are treated as spares. Convenience aids offered as accessories are not subject to the IVDD.

Appendix B Approved Reagents

Introduction

This Section lists all the reagents specified by Thermo for use with the Shandon Excelsior ES tissue processor.

If you want to use a reagent not included in this list, contact your Thermo agent for advice.

WARNING

Do not use any reagents containing calcium chloride.▲



REFER TO THE MATERIAL SAFETY DATA SHEETS (MSDs) WHEN HANDLING THE REAGENTS LISTED IN APPENDIX C. ▲

Reagent List

Fixatives

Formalin
Glyo-Fixx™

Dehydrants

Ethanol
Methanol (up to 10% in ethanol)
IMS (Industrial Methylated Spirits)
Isopropyl alcohol

Clearants

Xylene
Toluene
Shandon Xylene Substitute
Chloroform

Infiltrants

Paraffin Wax

Flush Reagents

Xylene
Toluene
Shandon Xylene Substitute

Alcohols from dehydrants list
Water

Cleaning Agents Dilute detergent
Water

Appendix C Program Examples

Introduction

These are the default programs installed on Excelsior ES.

Routine Overnight Program

	REAGENT	HOLD / USE	TIME	DRAIN	VACUUM	STIR
1	Formalin	Amb	00:30	30	Off	5
2	Formalin	Amb	00:30	60	Off	5
3	Alcohol	30	01:00	30	On	5
4	Alcohol	30	01:00	30	On	5
5	Alcohol	30	01:00	30	On	5
6	Alcohol	30	01:00	30	On	5
7	Alcohol	30	01:00	30	On	5
8	Alcohol	30	01:00	60	On	5
9	Xylene	30	01:00	30	On	5
10	Xylene	30	01:00	30	On	5
11	Xylene	30	01:00	60	On	5
12	Wax	60	01:20	120	On	5
13	Wax	60	01:20	120	On	5
14	Wax	60	01:20	120	On	5

Rapid Biopsy Program

	REAGENT	HOLD / USE	TIME	DRAIN	VACUUM	STIR
1	Formalin	Amb	00:30	30	Off	5
2	Formalin	Amb	00:30	60	Off	5
3	Alcohol	30	01:00	30	On	5
4	Alcohol	30	01:00	30	On	5
5	Alcohol	30	01:00	30	On	5
6	Alcohol	30	01:00	30	On	5
7	Alcohol	30	01:00	30	On	5
8	Alcohol	30	01:00	60	On	5
9	Xylene	30	01:00	30	On	5
10	Xylene	30	01:00	30	On	5
11	Xylene	30	01:00	60	On	5
12	Wax	60	01:20	120	On	5
13	Wax	60	01:20	120	On	5
14	Wax	60	01:20	120	On	5

Standard Flush Program

	REAGENT	HOLD / USE	TIME	DRAIN	VACUUM	STIR
1	Flush 1	Amb/60	00:20	30	Off	5
2	Flush 2	Amb/45	00:03	30	Off	5
3	Flush 3	Amb	00:02	30	Off	5

Extended Flush Program

	REAGENT	HOLD / USE	TIME	DRAIN	VACUUM	STIR
1	Flush 1	Amb/60	00:30	30	Off	5
2	Flush 2	Amb/45	00:05	30	Off	5
3	Flush 3	Amb	00:02	30	Off	5

Rinse Program

	REAGENT	HOLD / USE	TIME	DRAIN	VACUUM	STIR
1	Flush 3	Amb	00:02	30	Off	5

Appendix D Transportation Instructions

Introduction

If the instrument is to be transported, follow these packaging instructions, after unloading ALL reagents and wax.

- Use ALL original packaging
- Keep the instrument upright at ALL times

Packaging the Instrument

1. Place the base of the packaging in a clear area. 3m is required in front of the packaging for the ramp and approximately 1m is required behind the packaging.

Lower the ramp of the packaging.

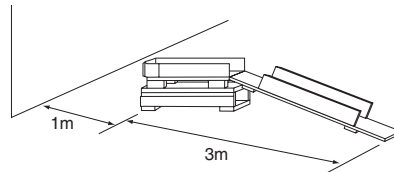

2. Fit the handles to the back of the instrument.



WHEN MOVING EXCELSIOR ES, USE SAFE LIFTING PRACTICES. EXCELSIOR ES WEIGHS APPROXIMATELY 112 KG (246 LB) WHEN EMPTY AND 200KG (440LB) WHEN FULL. AT LEAST TWO PEOPLE ARE NEEDED TO SAFELY MOVE THE INSTRUMENT. ▲

3. Carefully wheel the Shandon Excelsior ES up the ramp until it sits securely in the base.

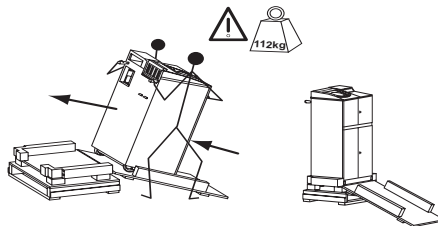

4. Remove the handles and secure them at the back of the instrument.

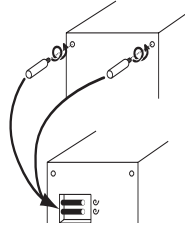

5. Make sure that the foam pieces are in place.
Raise the ramp and fit the Inner Cover.

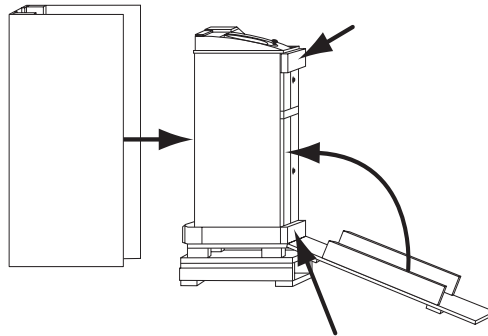

6. Secure the ramp to the Inner Cover with tape.
Fit the Outer Cover.

7. Fit the lid over the Outer Cover.

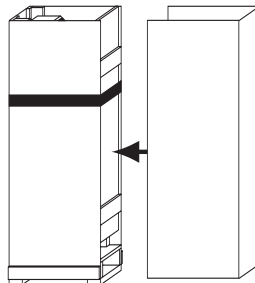

8. Secure the packaging by two bands through the palette and over the lid , and one band around the bottom of the packaging.

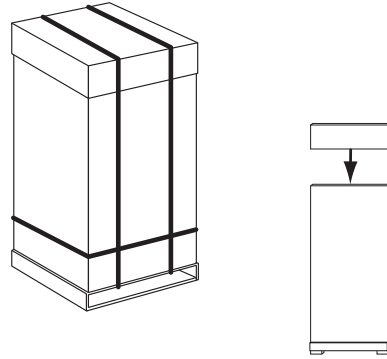

WHEN TRANSPORTING EXCELSIOR ES AFTER PACKAGING ENSURE THAT THE INSTRUMENT IS KEPT UPRIGHT AT ALL TIMES. ▲

PRODUCT RETURN SAFETY DECLARATION

Part 1 Decontamination Certificate

Any instrument or part of any instrument must be clean before being returned, and where necessary accompanied by a completed Decontamination Certificate. Should the instrument or any part of it be received in an unclean condition, or Thermo Fisher Scientific consider it to be a hazard, the instrument or part will be returned unrepaired at the expense of the customer.

It is important that the certificate is forwarded by post or fax, and a copy attached to the exterior of the container. Containers will not be opened until the company is in possession of the required certificate.

This form **MUST** be completed by the customer and **NOT** by a Thermo Fisher or distributor employee.

If an instrument or part is to be returned to Thermo Fisher Scientific, please note the following:

- 1 If the instrument or any part of it has been exposed to, or been in contact with potential pathogenic or radioactive material, it is essential that it is decontaminated.
- 2 Set procedures are laid down in the European Health and Safety Directives for decontamination. To avoid any misunderstanding, we request that all instruments or parts returned to us must be accompanied by a certificate stating the following:

We certify that this (Model)..... Serial No.....

- has not been exposed to pathogenic, radioactive or other hazardous material and has been cleaned

OR

- has been decontaminated and cleaned (if exposed to the above) according to approved procedures following exposure to:

- Has the instrument been used for work with human or animal Transmissible Spongiform Encephalopathies, e.g. Creutzfeld-Jacob disease, Scrapie or BSE?

YES / NO

If yes, please contact Thermo Fisher Service before taking any further action.

Signed Position

Name (Block Capitals)

Company or Organisation

Full Address

Part 2 Guidelines for Returning Instruments

Please use the checklist below to ensure that the instrument being returned is ready for collection.

- All reagents / wax removed from instrument, including vapour traps (if applicable).....
- Accessories are secured / itemised
- Instrument has had transit clamps fitted as per Operator Guide (if applicable).....
- Instrument is packed in original packaging..... YES / NO

RMA NUMBER

CARRIER

FOR ATTENTION OF

Thermo Fisher Scientific, Anatomical Pathology, 4481 Campus Drive, Kalamazoo, MI 49008, USA

Tel: 1-800-522-7270, Fax: +1 269-372-2674, www.thermo.com/pathology

Thermo Fisher Scientific, Anatomical Pathology, 93-96 Chadwick Road, Astmoor, Runcorn, Cheshire, WA7 1PR, UK

Tel: +44 (0)1928 562600, Fax: +44 (0)1928 562627, www.thermo.com/pathology

WARRANTY STATEMENT

We are proud of our quality and reliability, and of our after-sales service. We continuously strive to improve our service to our customers.

Please ask your distributor or representative about Service Contracts which can keep your purchase in peak condition for many years to come.





Warranty provisions necessarily vary to comply with differences in national and regional legislation, and you can find details in your delivery documents or from your dealer or representative.

Please note that your warranty may be invalidated if:

- The instrument is modified in any way.
- Accessories and reagents are used that are not approved by Thermo, or;
- The instrument is not operated or maintained in accordance with the instructions in this Operator Guide.

Index

Symbols

- [] biohazard symbol 6
- [] harmful chemical symbol 6
- [] pinchpoint symbol 6
- [] warning symbol 1 6
- [] warning symbol 2 6

A

- Access codes 77
 - Administrator 77
- Agitation 15
 - drive pins 24, 64
- Alarms
 - remote audio 80
 - silence alarm button 80, 96
- Arrow keys 19

B

- Biohazard symbol [] 6

C

- Centre of Gravity 114
- Changing a program title 51
- Clearant
 - approved 119
 - position 20
- Conformity
 - declaration of 118
- contact addresses 2
- CONTROLS AND SCREEN LAYOUT
 - Screen Displays

Information Icons

- Quality Control Warning - 96
- Remote Alarm - 96

Customisation 43

D

- Daily Operations
 - processing
 - overview 20
 - Declaration of Conformity 118
 - Define Program screen 53
 - program steps 54
 - Defining reagent groups 41
 - reagent temperature 41
 - Dehydrants
 - loading 49
 - Dehydrant Reagent 42
 - Disk drive options 79
 - Downdraft
 - vent adaptor 90
 - Downdraft filter
 - fitting 89
 - Drain
 - drain wax 82
 - Drain options 28, 67
- ## E
- Earthing / Grounding Details 8
 - Edit program 51
 - add notes 51
 - change notes 52
 - drain 54
 - setting reaction chamber vacuum 54
 - Electrical Specification 113, 114
 - Emergency vacuum release 99

Environmental conditions 114
EXAMPLE ROUTINES
Extended Flush Program 122
Rapid Biopsy Program 121
Rinse Program 122
Routine Overnight Program 121
Standard Flush Program 122

Extraction filters
fitting 87

F

Fault Status screen 97

Filters 87
extraction filters
upper filter - potassium
permanganate) 88
lower filter - carbon 88

Fixative
approved reagents 20

Flush
preparing chamber for first use 50

Flush program
standard, extended 28, 68

Fuse
mains plug 90
mains input 114

H

Heater reset switch 91

Height 113

I

Information button  19

Inspect

reagent and wax checks 98

Installing Excelsior

connecting monitor 87

electrical requirements

wiring details 91

fitting filters

extraction filters

lower filter - carbon 88

upper filter - potassium
permanganate 88

introduction 63, 85, 95, 105, 108,
119, 123

Instrument Depth 113

Instrument Height 113

Instrument Weight 9, 113

Instrument Width 113

L

Levelling

instrument 86

LIMS interface 113

Loading reagents

fixatives 48

fixed reagents 49, 50, 89

M

Maintenance 10

regular 105

Monitor 87

N

Notes

add Notes feature 52

O

organised baskets 16, 17

P

Physical Specification 113

Pinchpoint symbol [

Powering OFF the instrument 103

Powering the instrument

OFF 93

ON 91

Power Supply Requirements 113, 114

Printout options 78

Processing Problems - troubleshooting 98

Hard, Brittle Tissue 101

Soft, Spongy Tissue 100

Product Return Safety Declaration 126

Programs

rapid biopsy 121

routine overnight 121

Program select

Program select screen 53

Q

Quality Control

override QC warnings 77

R

Reaction chamber

heater trip 96

Reagent rotation 32, 72

control all groups 34, 74

rotation management 57

Reagent storage area 38

Reagent Tubes 47

Regular maintenance 38

Removing specimens

Drain options 28, 67

Rinse program 122

S

Safety information 8

Set LIMS interface 80

SPECIFICATION AND ACCESSORIES

Accessories

Instrument accessories 115

baskets 115

extraction adaptor kits 115

Reagents 116

Specification 114

Centre of Gravity Positions 114

Electrical 114

Environment 114

Part Numbers 114

Physical 114

Switch Convention 114

T

Transportation

instructions 123

Troubleshooting

instrument function - table 1 98

processing problems

hard, brittle tissue - table 3 101

increasing process time 100

soft, spongy tissue - table 2 100

U

Underfill

 alert displayed 99

User access groups 77

V

Vacuum release knob 99

Vent adaptors 89

W

Warranty statement 127

Waste wax 21, 32, 34, 72, 74
 liner 45

Wax

 loading wax 44

 melting wax 46

 wax bath heater 46

 paraffin wax pellets 21

 adding 33, 35, 73, 75

 storage temperature 41

 waste wax container WW

 removing 32, 34, 72, 74

 wax rotation 32, 72

Wax Waste Tray 108

Wiring details 91

X

Xylene

 loading clearants 49

 substitute, ordering 116